

*COMSOL as a tool for studying
Magneto-Hydro-Dynamic effects in liquid
metal flow under transverse magnetic
field*

S. Sahu, R.P.Bhattacharyay

E. Rajendrakumar

IPR

Content

- Introduction
- Problem definition
- Equations involved
- Mesh
- Results
- Conclusion

Introduction

- ✓ Magneto-hydro-dynamics (MHD) is the study of dynamics of an electrically conducting fluids under the presence of transverse magnetic field
- ✓ The fundamental concept behind MHD is that magnetic fields can induce currents in a moving conductive fluid, which in turn creates forces on the fluid and also changes the magnetic field itself.
- ✓ The field of MHD was initiated by [Hannes Alfvén](#) and got Nobel prize in 1970
- ✓ Examples of such fluids: plasmas, [liquid metals](#), and salt water or electrolytes
- ✓ MHD applications: Astrophysics (planetary magnetic field), MHD pumps (1907) , MHD generators (1923), MHD flow meters (1935), MHD flow control (reduction of turbulent drag), Magnetic filtration and separation, Fusion reactors (blanket, divertor, limiter, FW)
- ✓ To study issues related to aforesaid examples using a software it is highly essential to validate the software
- ✓ At present, It was tried to validate COMSOL as a tool for studying the **MHD issues in liquid metal flows**
- ✓ A well established relation [\[1\]J.C.R.Hunt \(1965\)](#) was used and the same was studied in COMSOL to have a comparison

Problem Definition

Infinitely conducting Hartmann wall

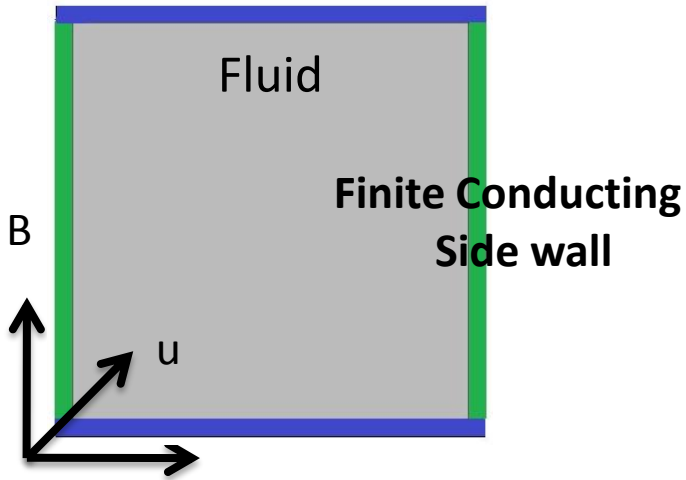

- 25×25 mm² square channel
- 1mm thick wall
- Uniform magnetic field 1T~4T
- Hartmann number (Ha) = 250 ~ 1038
- **Steady state Velocity profile** is studied

$$Ha = Bd \sqrt{\frac{\sigma}{\rho\nu}}$$

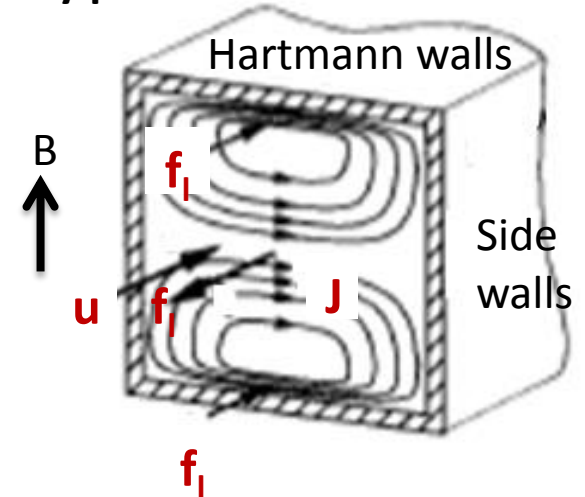

What to expect ?

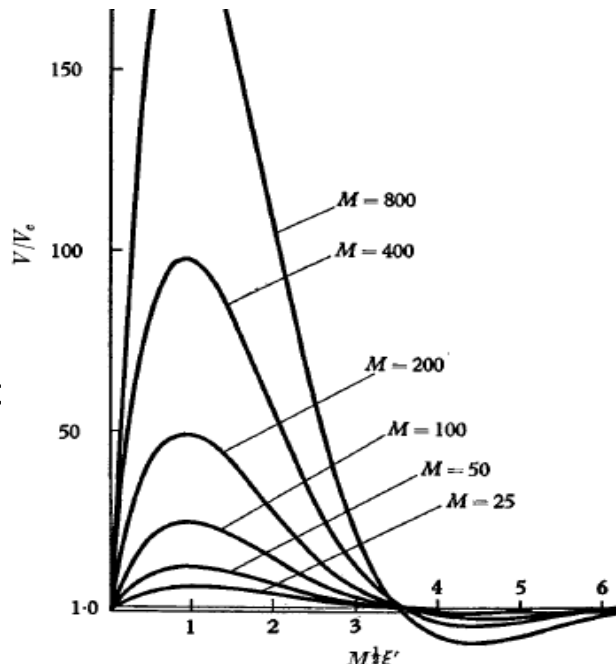
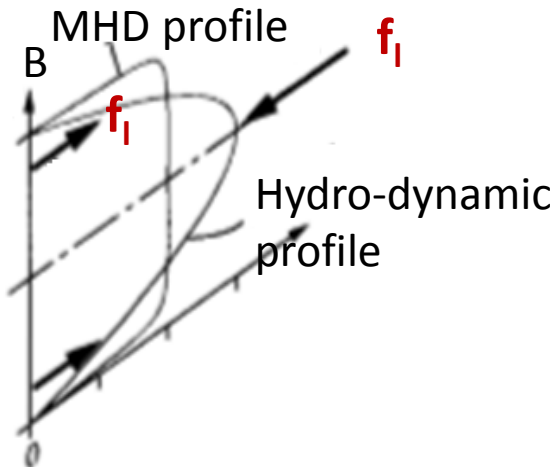

[1] J.C.R. Hunt (1965)

Hartmann number is the ratio of electromagnetic force to the viscous force
Hartmann wall is the wall perpendicular to the magnetic field
Side wall is the wall parallel to the magnetic field.

Equations Involved

Assumptions

- ✓ Steady state laminar flow
- ✓ Incompressible Newtonian fluid
- ✓ No slip at the wall-liquid interface
- ✓ Quasi-static approximation

Navier Stoke's equation(Momentum Conservation)

$$\rho(\mathbf{u} \cdot \nabla)\mathbf{u} = \nabla \cdot [p\mathbf{I} + \mu(\nabla\mathbf{u} + (\nabla\mathbf{u})^T)] + \mathbf{J} \times \mathbf{B}$$

Continuity equation (Mass Conservation)

$$\rho \nabla \cdot \mathbf{u} = 0$$

Generalised Ohm's Law

$$\mathbf{J} = \sigma(\mathbf{E} + \mathbf{u} \times \mathbf{B})$$

Current conservation Equation

$$\nabla \cdot \mathbf{J} = 0$$

Maxwell's equation

$$\mathbf{E} = -\nabla \varphi$$

Poisson's Equation

$$\nabla^2 \varphi = \nabla \cdot (\mathbf{u} \times \mathbf{B})$$

Boundary Conditions

- ✓ For Fluid flow
 - ✓ Inlet $u_x = 0.01 \text{ m/s}$, $u_y = u_z = 0$
 - ✓ Outlet $P = 0$
- ✓ For Electromagnetic analysis
 - ✓ $\varphi = 0$ at all boundaries
 - ✓ $\mathbf{n} \cdot \mathbf{J} = 0$ and $\mathbf{n} \times \mathbf{A} = 0$ at all outer boundaries

Peculiarity about Liquid Metal MHD

- A number of equation to be solved simultaneously
- Normal Pipe flow gets modified into M-shaped profile (Instable flow)
- Solver settings has to be set properly
- Hartmann layers thickness ($\sim 1/\text{Ha}$)

[$\sim 3.8\text{e-}3$ - $9.64\text{e-}4$ m in our case]

$$\delta = \frac{1}{B} \sqrt{\frac{\rho \nu}{\sigma}}$$

- Side layer thickness ($\sim 1/(\text{Ha})^{1/2}$)

[$\sim 6.2\text{e-}2$ - $3.1\text{e-}2$ in our case]

- Mesh should be sufficiently dense to capture the phenomena occurring at this thickness

Mesh

Hartmann layer thickness $\sim 1/Ha$
Side layer thickness $\sim 1/(Ha)^{1/2}$

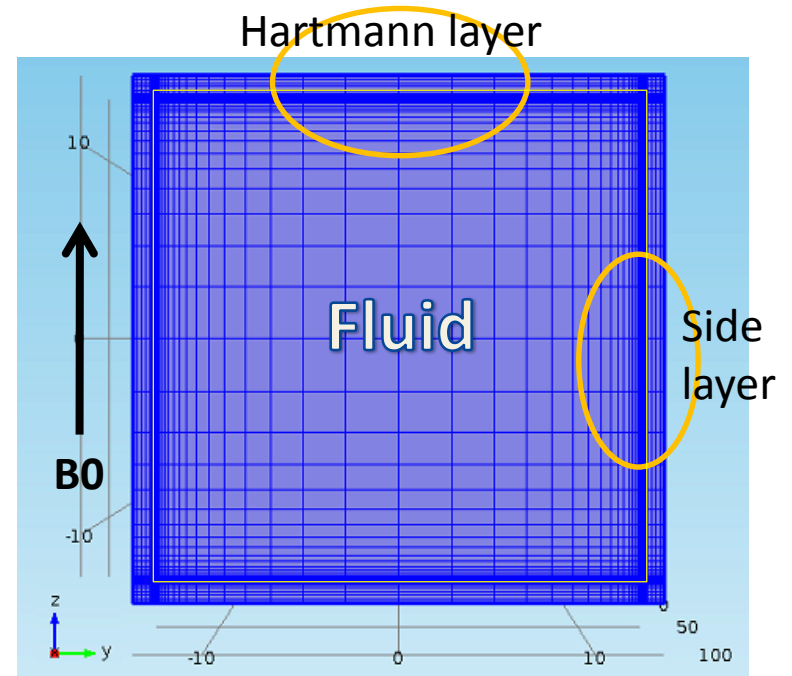
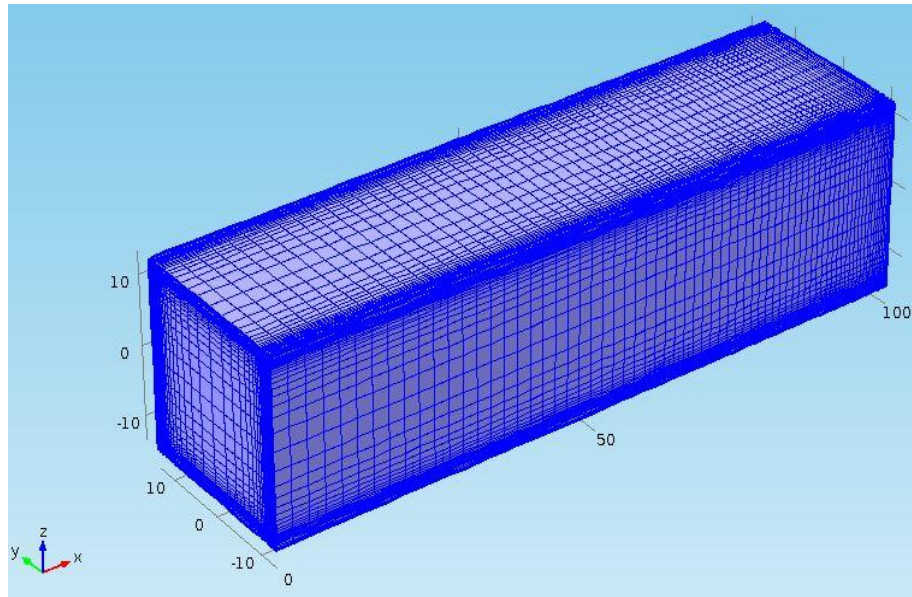

Minimum Mesh thickness along Hartmann layers = $2e-6$ m
Minimum Mesh thickness along side layers = $2e-4$ m

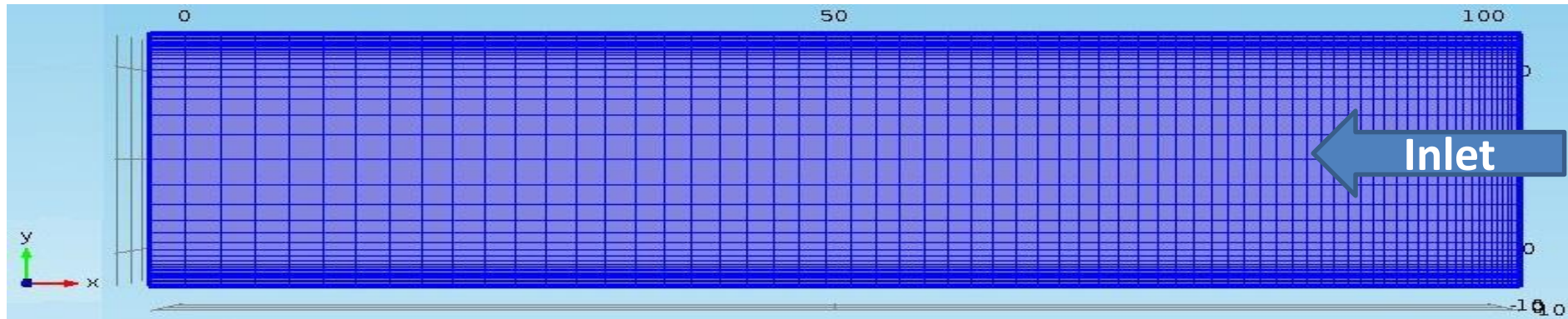

Inlet will have more velocity variation as compared to outlet

Velocity Comparison

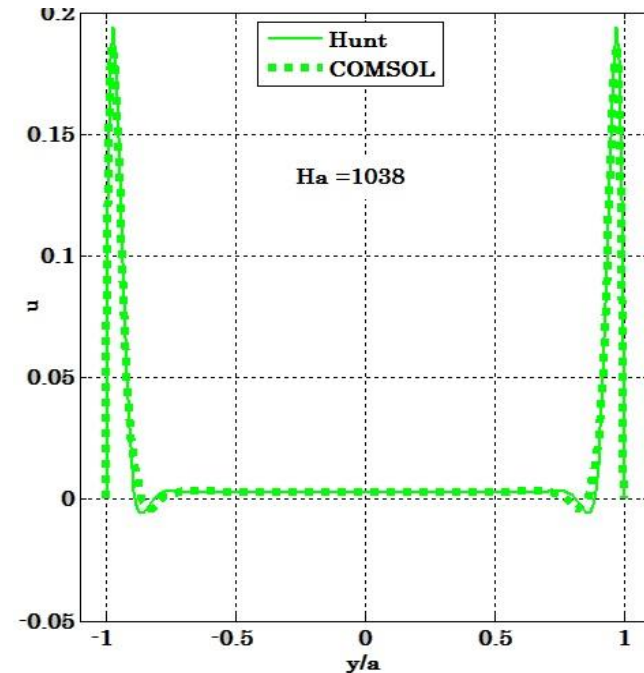
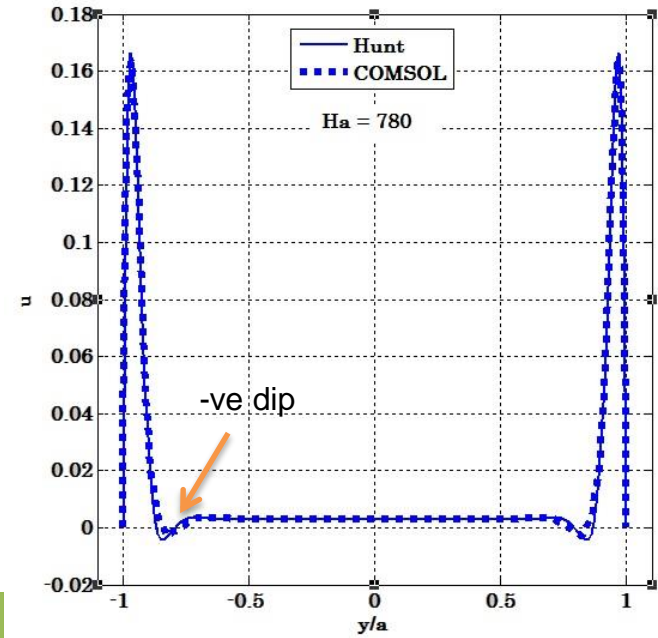
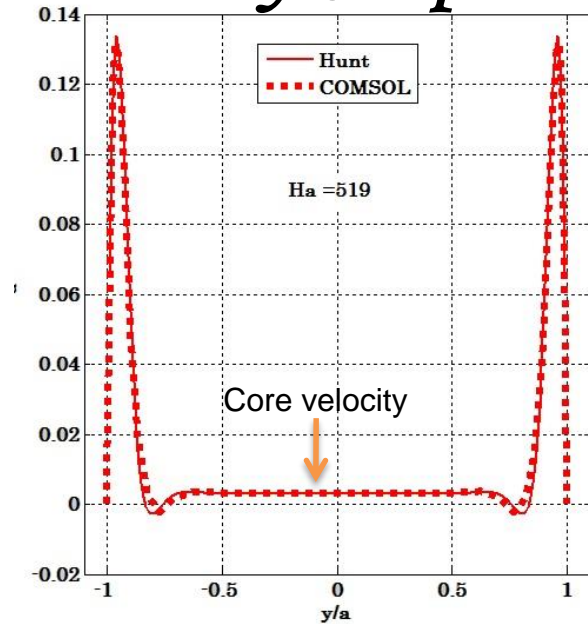
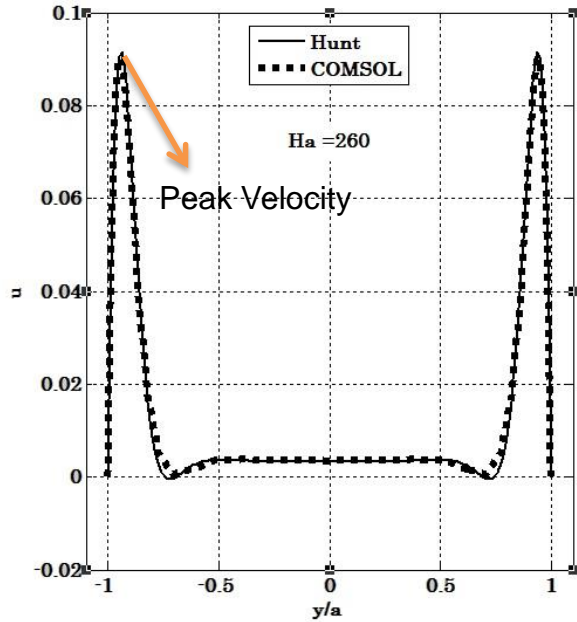

		Peak Velocity	Dip -ve Velocity	Core velocity
Ha=260	Hunt	0.09163	-0.0004762	0.003429
	COMSOL	0.090084	0.000632	0.003437
Ha=519	Hunt	0.1336	-0.002668	0.003142
	COMSOL	0.1314	-0.002515	0.003183
Ha=780	Hunt	0.1663	-0.004383	0.003039
	COMSOL	0.1633	-0.002912	0.003047
Ha=1038	Hunt	0.1938	-0.005673	0.002941
	COMSOL	0.1868	-0.00403	0.002966

Velocity Comparison

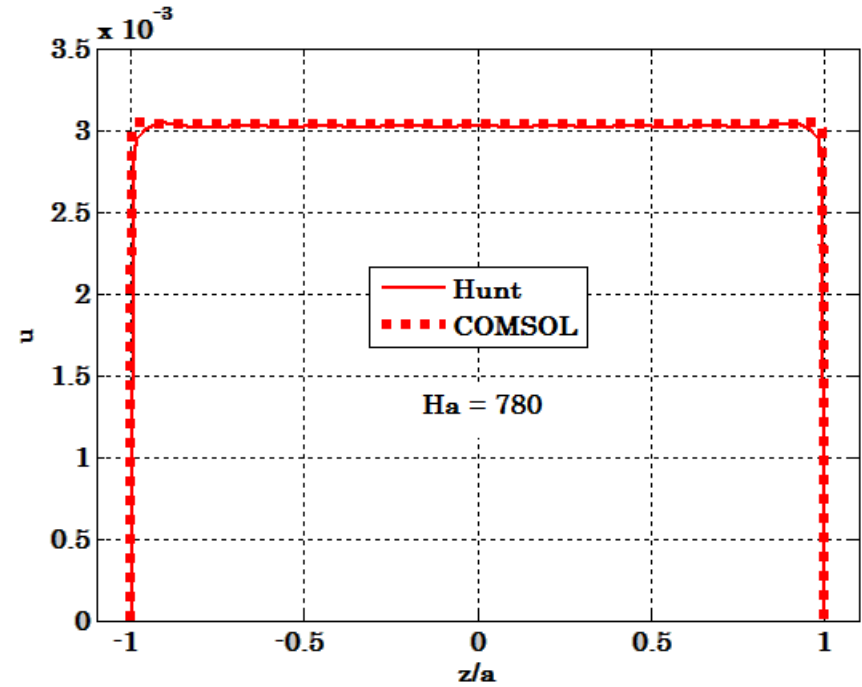
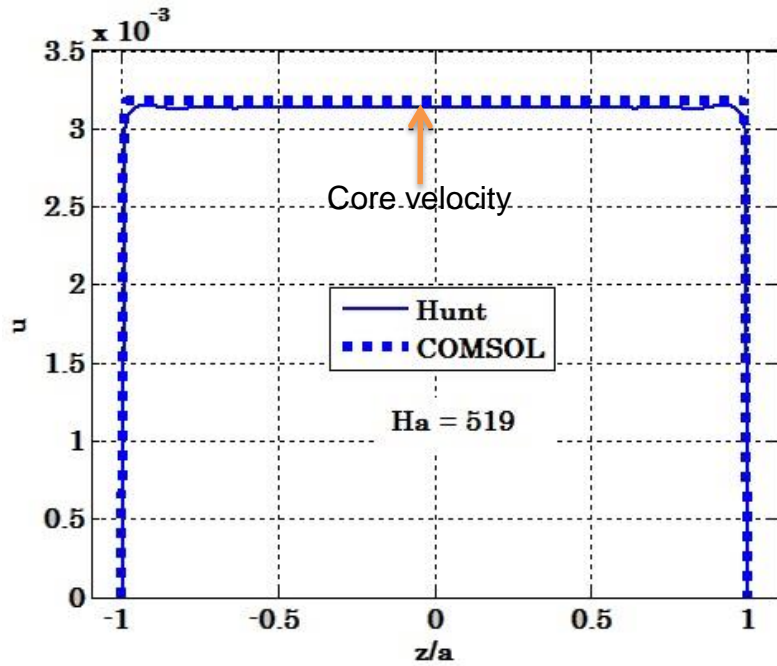

	Ha = 519	Ha = 780
Core velocity Hunt	0.003133	0.003024
COMSOL	0.003179	0.003033

Pressure Comparison

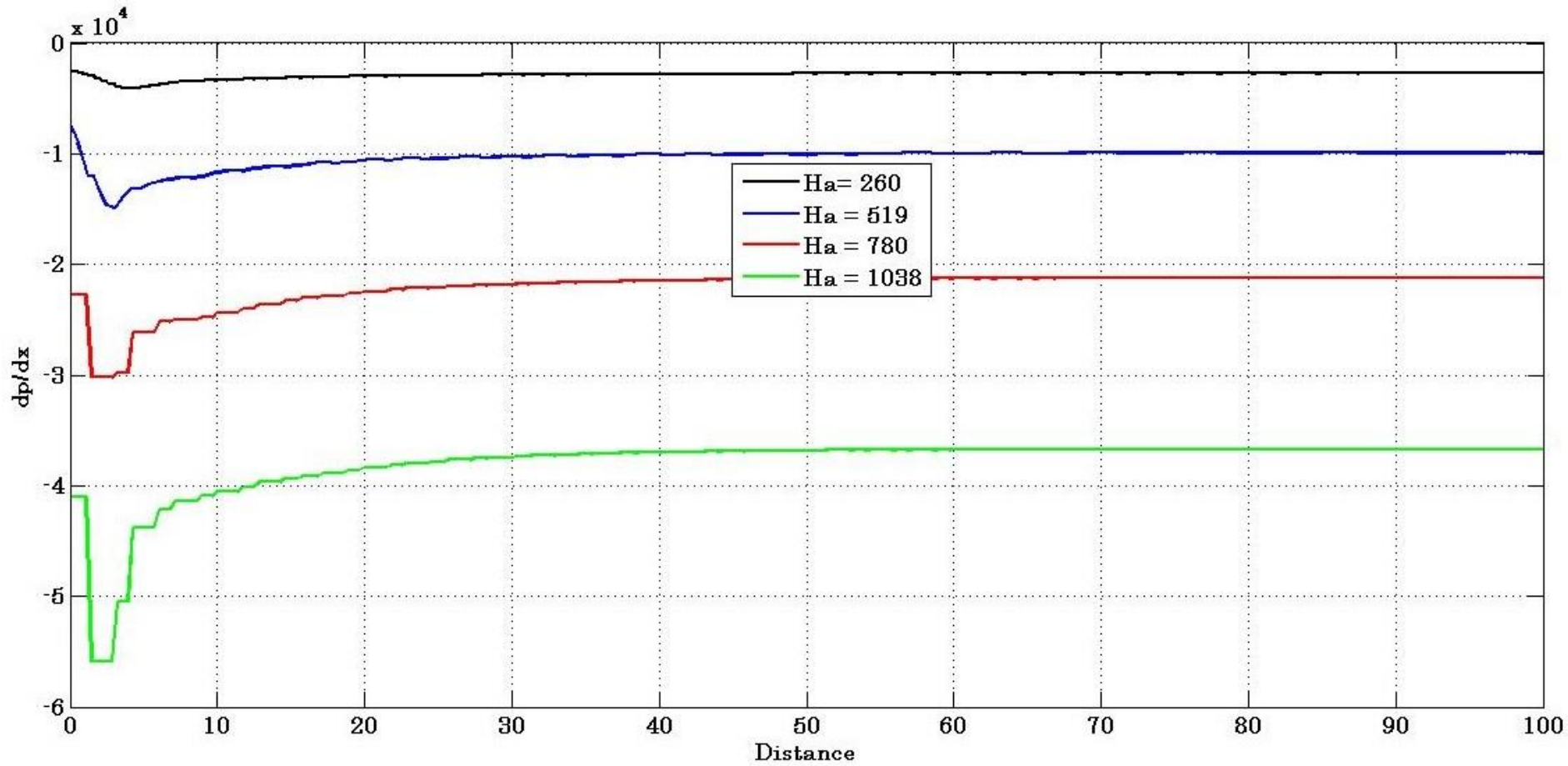

	Ha = 260	Ha = 519	Ha = 780	Ha = 1038
Hunt	2.66e3	9.73e3	2.11e4	3.63e4
COMSOL	2.7e3	9.85e3	2.12e4	3.67e4

Conclusion

- A model was simulated using COMSOL for a well known analytical relation
- The COMSOL results are matching well (Max 4% error) with the analytical results for velocity and pressure measurements, except at dip –ve velocity locations (Max 25% error)
- It is expected that the error can be minimised by increasing mesh density at that locations

Thank You

Reference

- J.C.R. Hunt, “Magnetohydrodynamic flow in rectangular ducts”, J. Fluid Mech. (1965), vol.21, part 4. Pp. 577-590
- “Magnetofluidynamics in Channel and containers” , U. Muller, L. Buhler, Springer.
- “Magnetohydrodynamics”, R. MOREAU, Vol3, kluwer academic publishers
- User’s Manual, COMSOL 4.3b