

# Simulation of Magnetic Flux Distribution of Stator and Rotor Coil of Superconducting Air Cored Wind Turbine Generator Using COMSOL Multiphysics

COMSOL  
CONFERENCE  
INDIA  
2012

Presented By  
Abhik Hazra  
Power Engg. Dept.  
Jadavpur University.  
Kolkata, Eest Bengal

# Energy & Civilization

- Energy is the ability to do work
- Obligatory part of mankind on the Earth
- Moves a nation, invites its prosperity

*Qas*

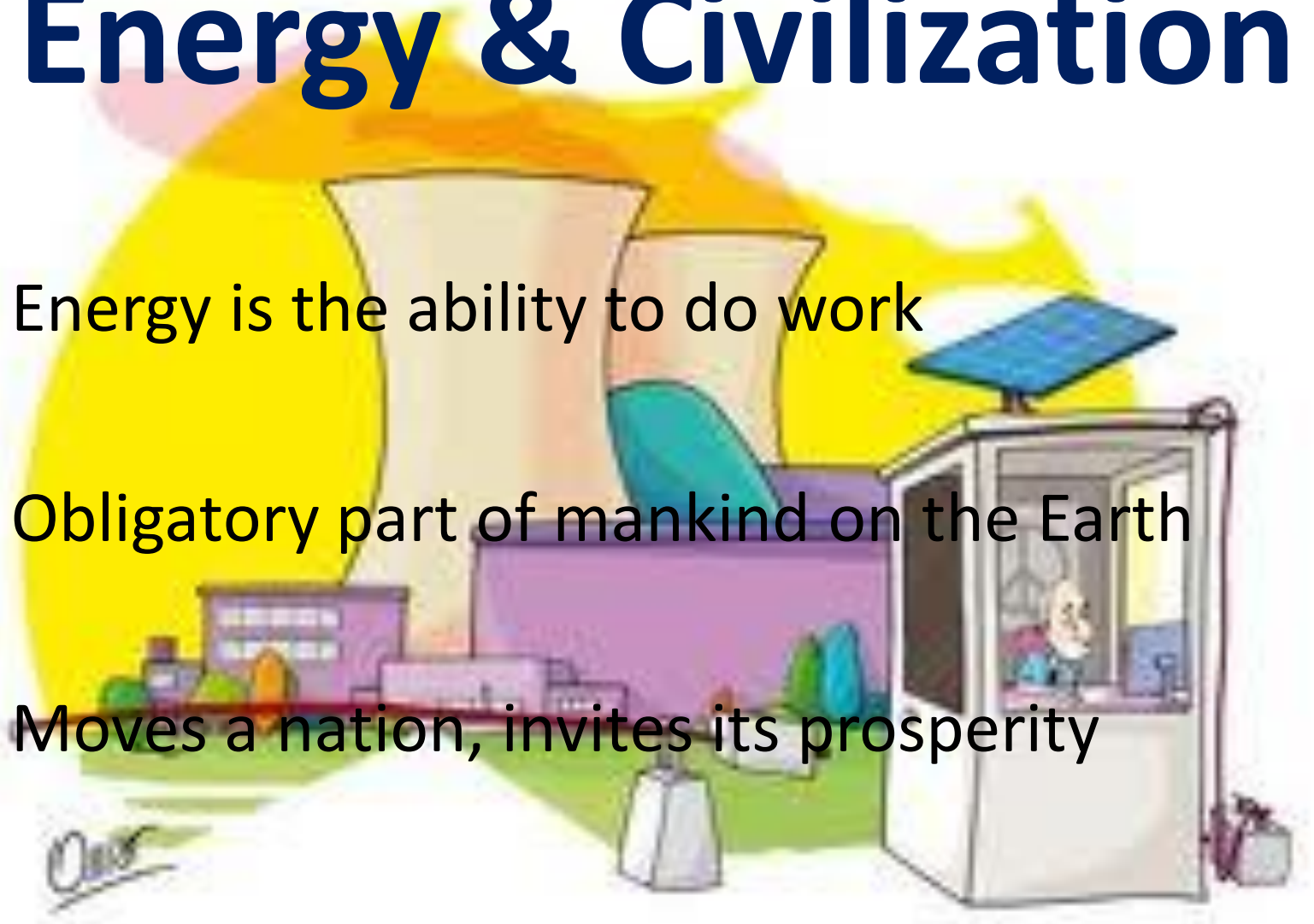

# Forms of Energy

- Heat Energy

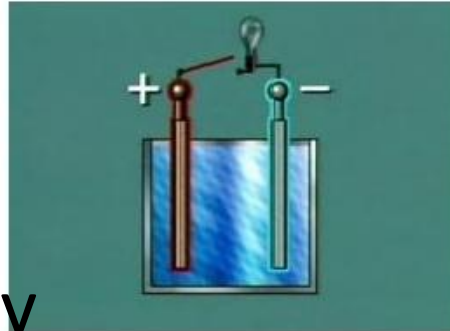

- Chemical Energy

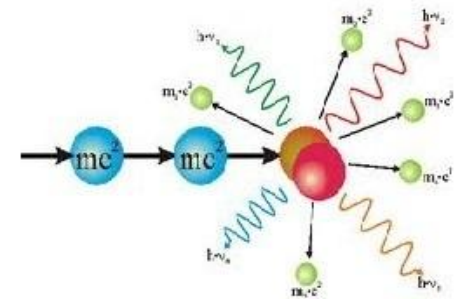

- Electromagnetic Energy

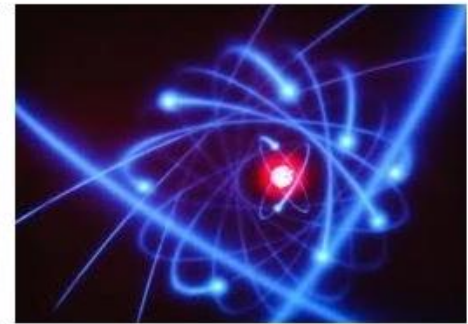
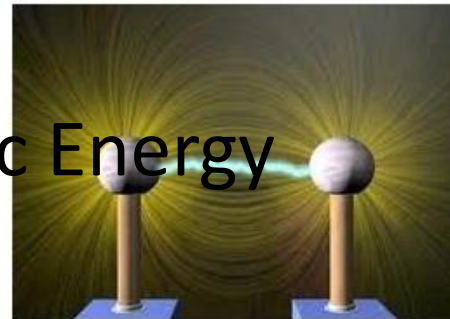

- Nuclear Energy

- Mechanical Energy



# Energy Conversion

- Energy can be changed from one form to another
- Energy can be neither created nor destroyed by ordinary means

# The Sun : a giant energy factory



- Almost all of the energy we use comes from the sun
- Primary & Secondary source of energy
- Renewable & Nonrenewable source of energy

# Electricity : The greenest form of energy

- Compact & clean form of energy
- Efficient transmission
- Efficiently usable

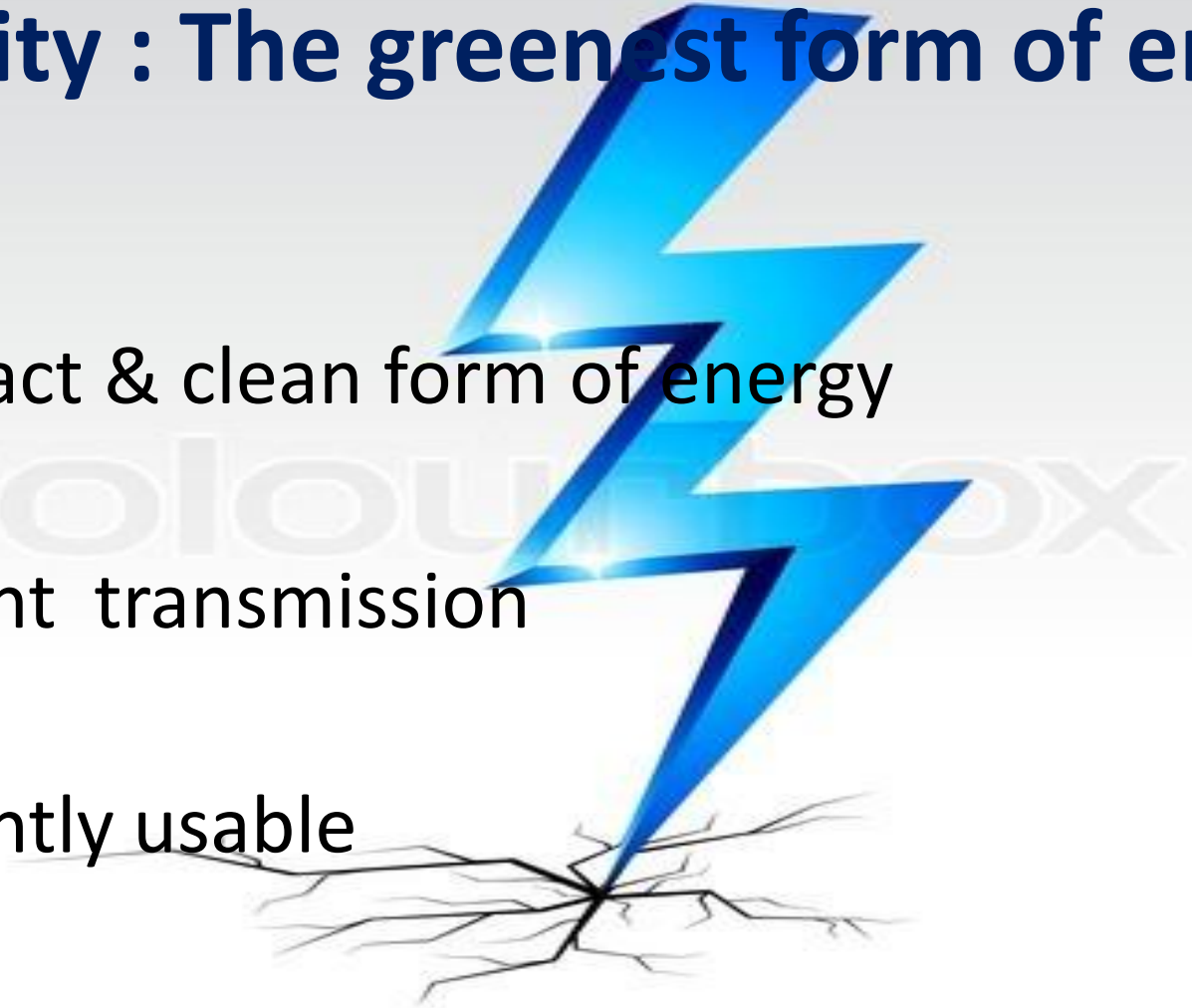

# Different Electricity generation Methodologies

- From Fossil Fuel : Coal, Mineral oil, Natural Gas
  - Harmful To nature
  - Reduced reserves : Only for some years
- From Nuclear Energy : Environmental hazards, radiation
- From Renewable Energy recourses : Solar, Wind, Geo Thermal, Tidal, Bio-Gas, etc.



# Wind Energy



- A Renewable Primary Source of energy
- Cause of wind flow
- Energy contained in wind
- Wind energy converter: converts wind power into electricity



# Electricity Generation from Wind

- Pollution free Green Methodology
- Continuously increasing popularity
- More effectiveness in large size wind turbine generator (> 5 MW WTG will produce more than 5 GW world wide by the year 2020)
- Offshore installation for better wind profile

# Direct Drive High Temperature Superconducting Wind Turbine Generator

- No Gear Box : Light weight
- Low Speed Generator needed
- HTS Generator : High magnetic Flux
  - High Power density
  - Power Generation in low RPM
  - Reduced Weight
- Recent trend of designing WTG

# Selected HTS WTG Model

- Circular Superconducting Field Coil : Uniform Stress
- Air Core : Reduced weight
- Both Radial and Axial Field coil
- Conventional copper Stator Coil
- 10 pole, 5 m diameter machine to achieve a class of 10 MW

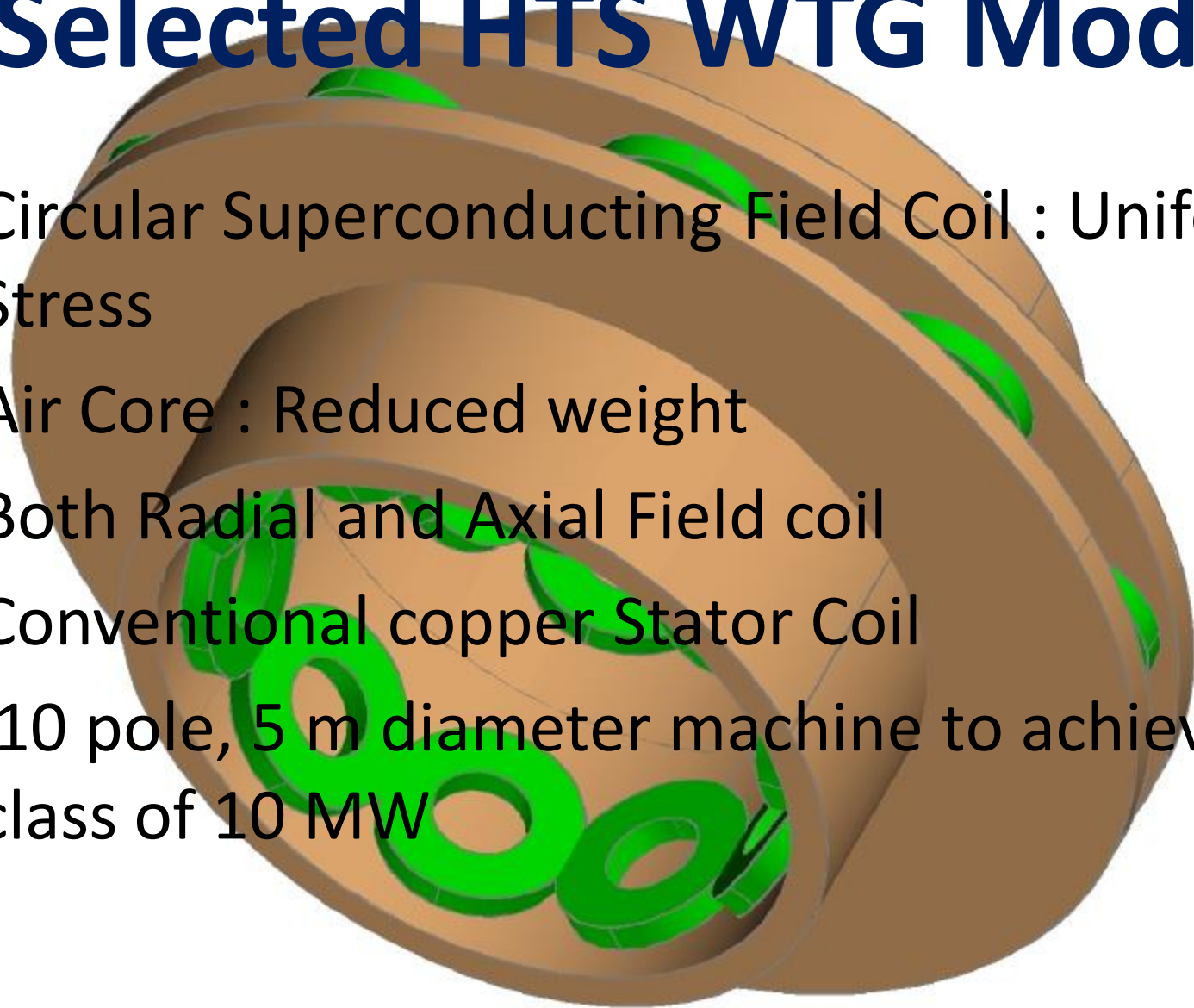

# Generator Model

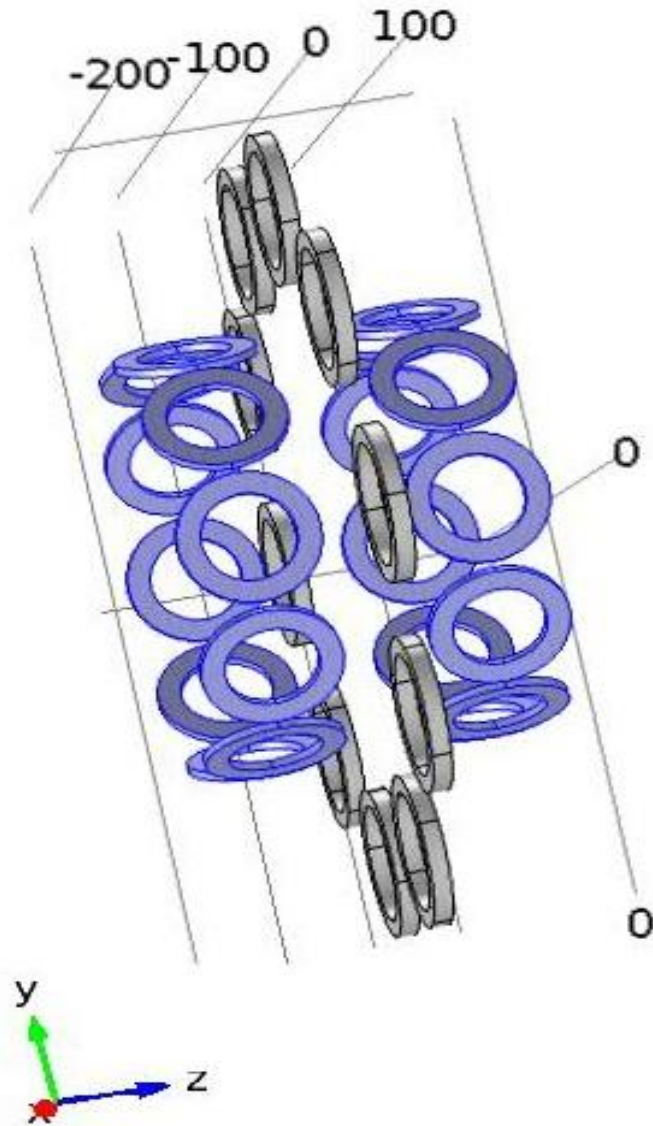
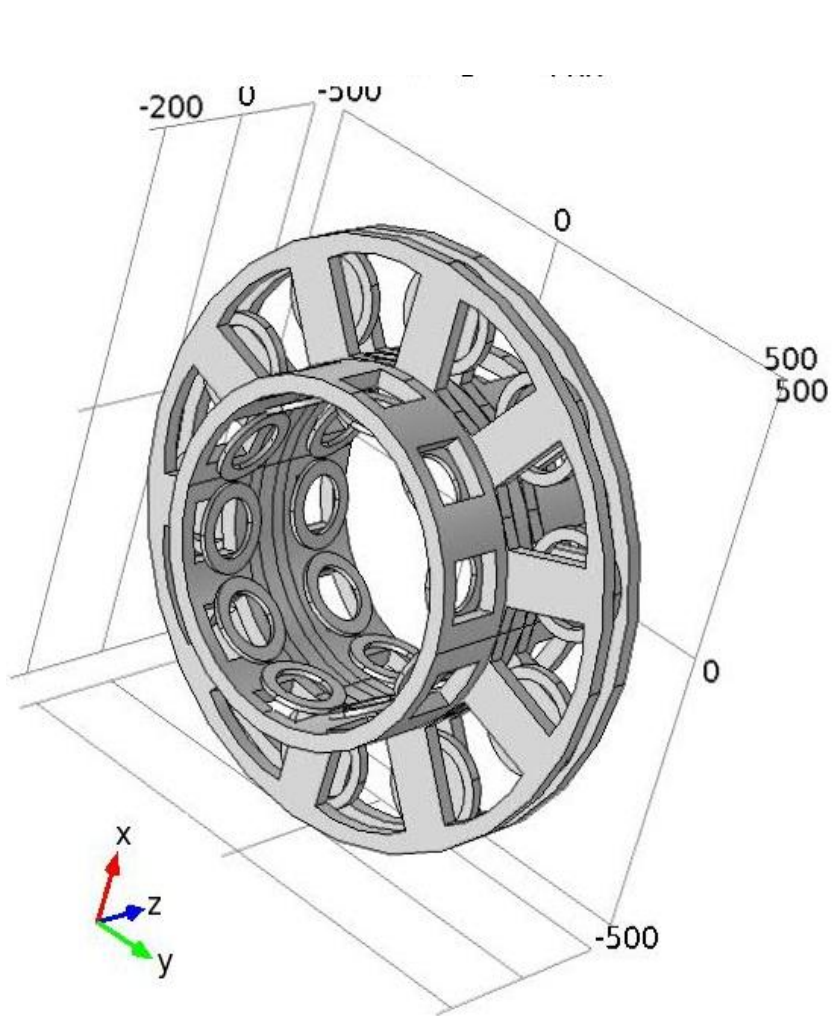

# Use of Comsol Multiphysics

- Model Geometry Was created by inbuilt 3D cad tool
- Material properties were assigned
- AC/DC module was selected as physics setting
  - Magnetic and Electric field
  - AV Formulation
- Study portal : Stationary Study
- Animation

# Meshing of the Model

- Tetrahedral Mesh : 3D mesh element
- Different size of mesh element
  - Finer mesh for superconducting coil surface
  - Fine mesh for stator coil
  - Coarser mesh for surrounding air

# Meshing of the Model

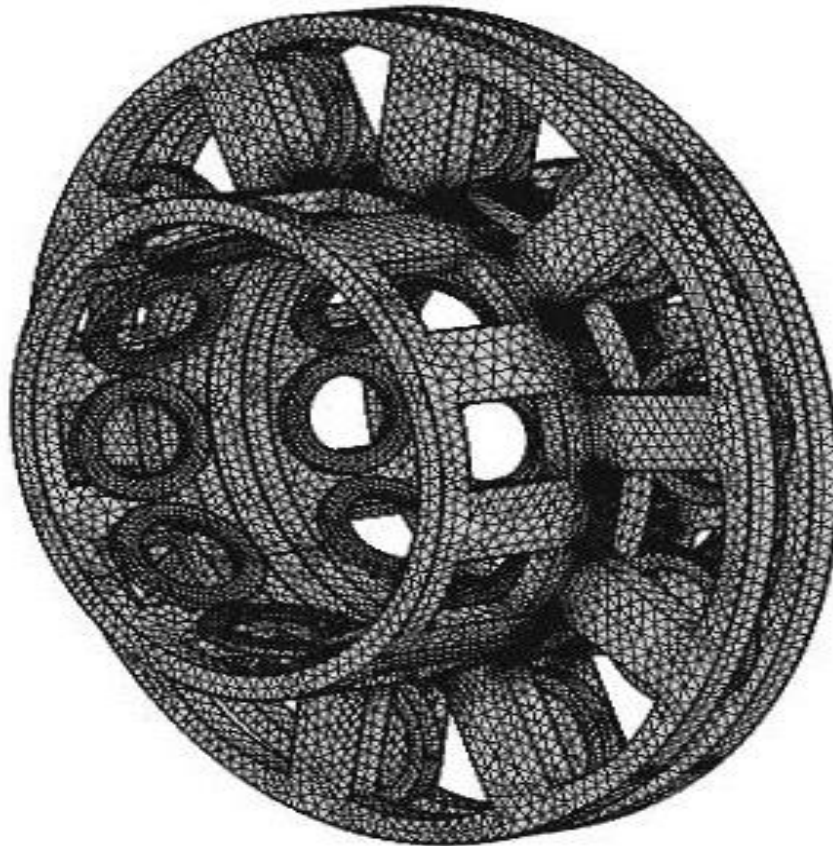

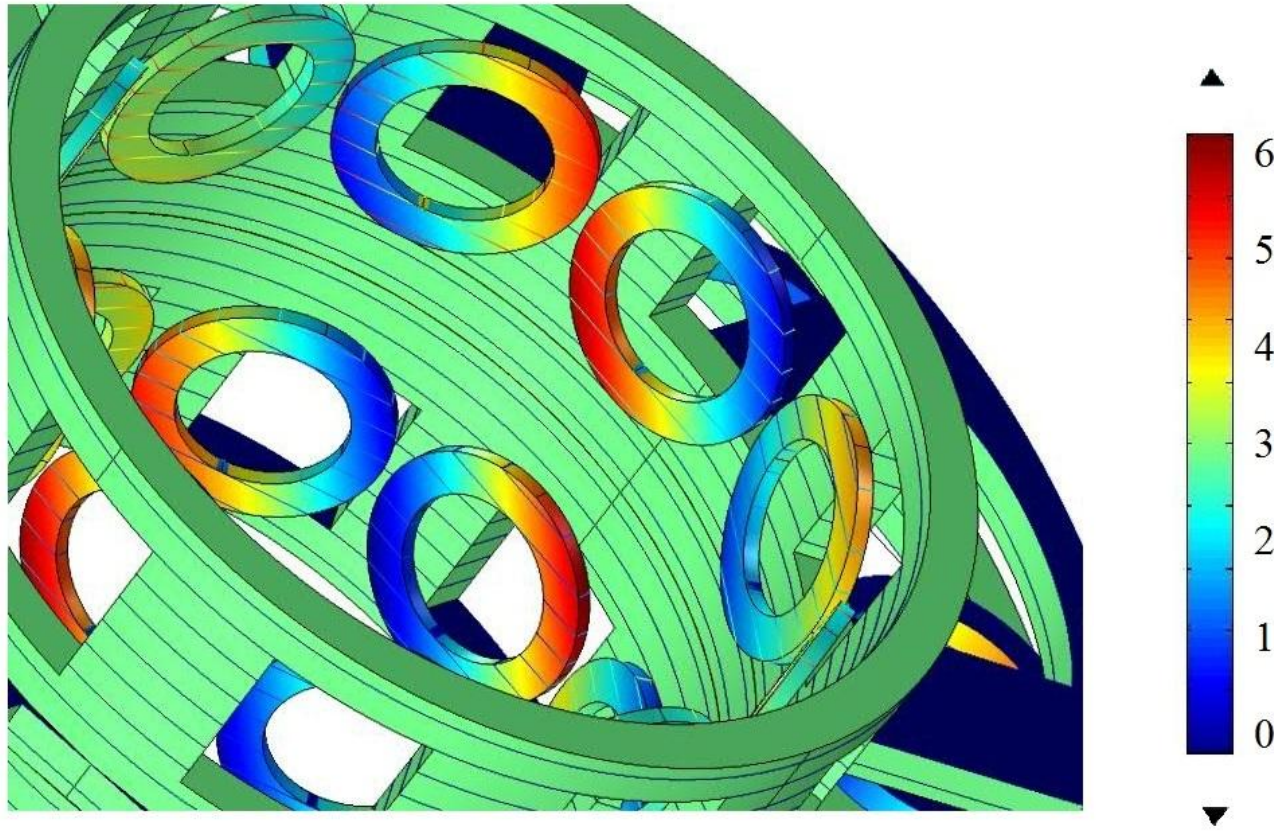

# Simulation of Magnetic Flux Distribution

## Distribution





# Comparative Study

Note new toolbar buttons: [data brushing](#) & [linked plots](#)   [Play video](#)

x

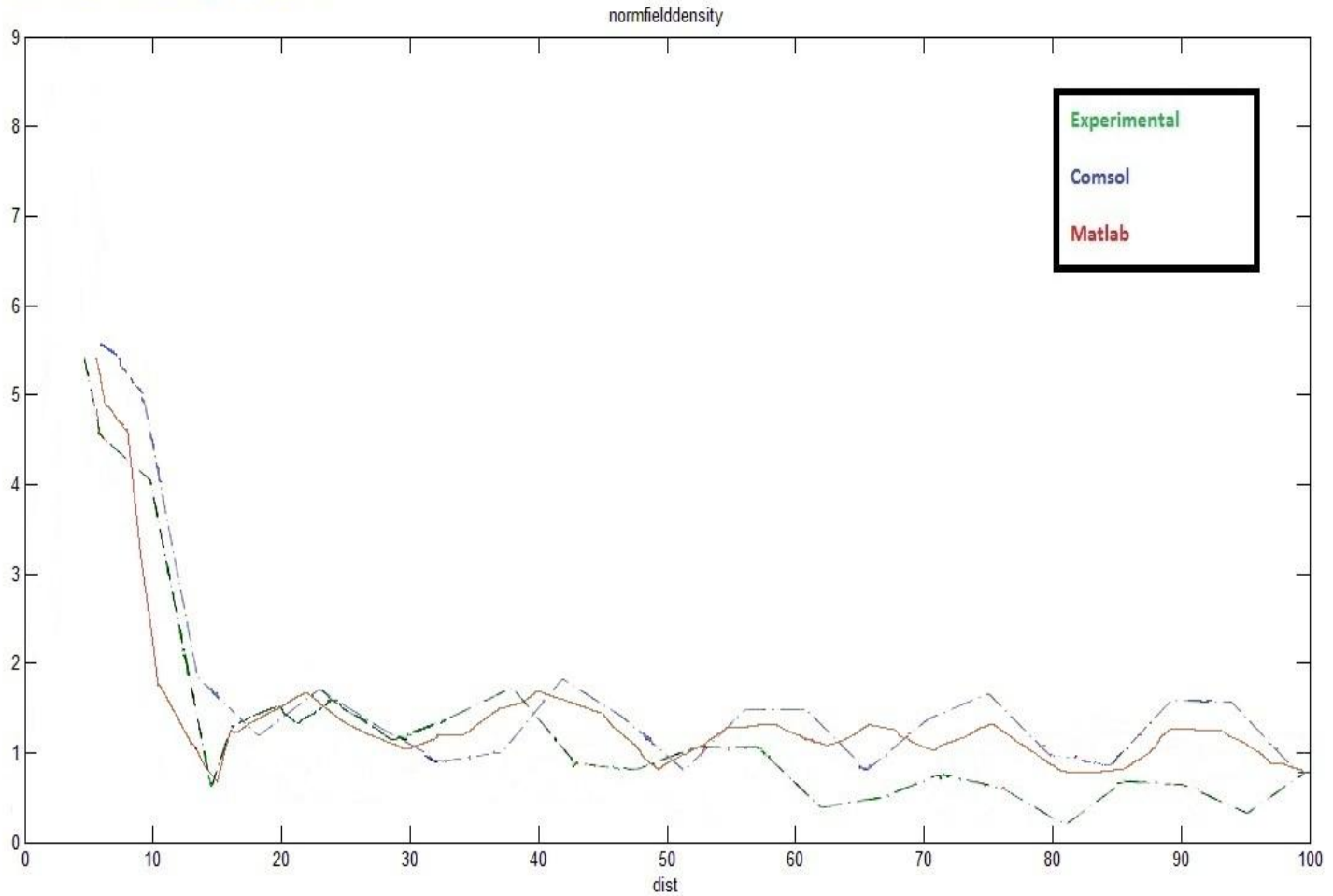

# Animation

