

Modeling of Pinna Related Transfer Functions (PRTF) using the Finite Element Method (FEM)

Manan Joshi

Navarun Gupta, Ph. D.

Lawrence Hmurcik, Ph. D.

University of Bridgeport, Bridgeport, CT

Objective

- Measure real Pinna Related Transfer Functions (PRTF)
- Find PRTF of a similar ear model in COMSOL that uses Finite Element Analysis method to solve the related Partial Differential Equations (PDEs).
- Compare the two for similarity

Introduction – HRTF & PRTF

- Head Related Transfer Functions (HRTFs) are signal processing models that represent the modifications undergone by the acoustic signal as it interacts with the listener's body.
- Pinna Related Transfer Functions (PRTFs) are signal processing models that represent the modifications undergone by the acoustic signal as it interacts with the listener's pinna (outer ear).
- PRTFs can be used to generate binaural sound elevation effects as they contain most of the information about the sound source's elevation.
- Pinna-Related Impulse Responses (PRIRs) Applications – *Entertainment, Virtual Video Games, Teleconferences, Aid for the visually impaired*

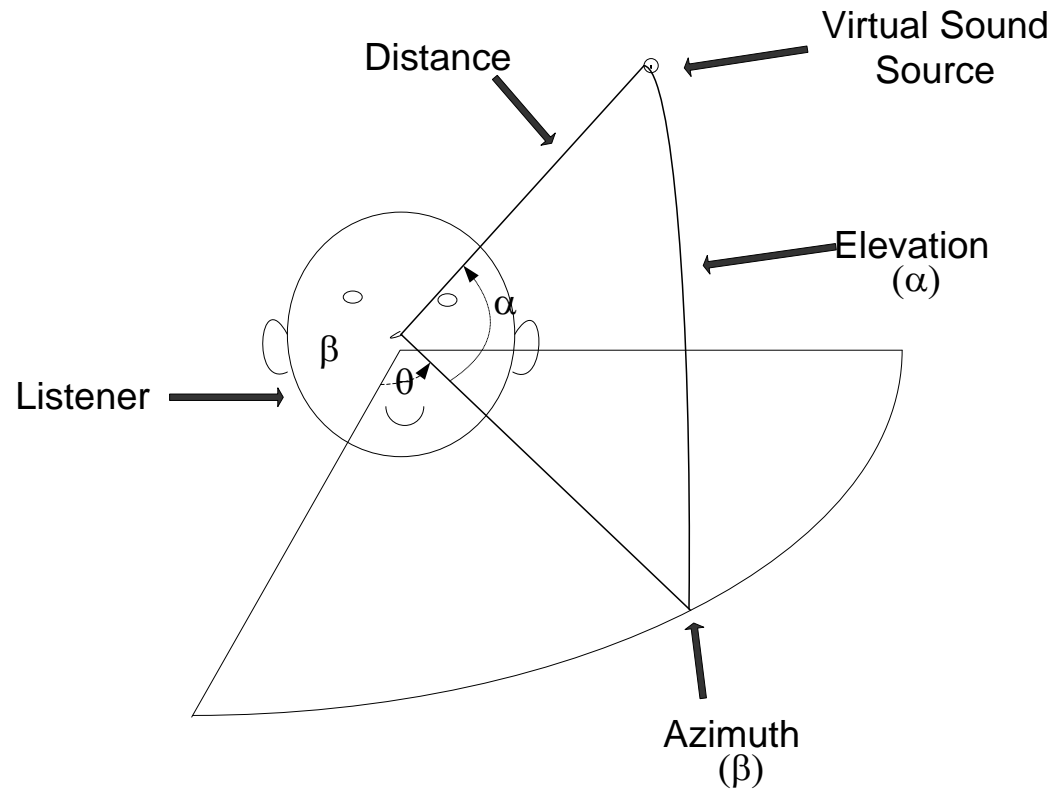

Figure 1. The spherical coordinate system used in this research

Head Related Transfer Function

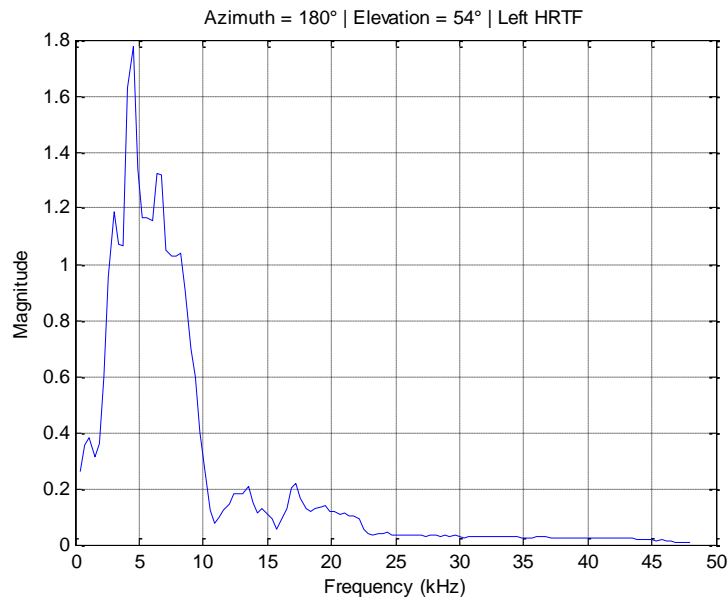

Figure 2. HRTF

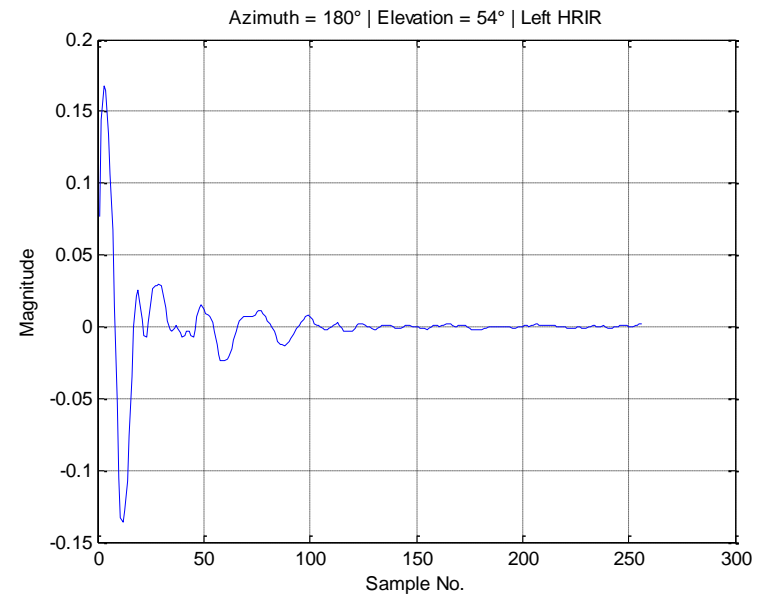

Figure 3. HRIR

Pinna Related Transfer Functions

- The outer ear (pinna) is a complex shaped organ responsible for shaping much of the HRTF in the higher frequencies.
- The complex shape of the pinna causes reflections, diffractions and resonances that give rise to a unique PRTF for each individual. The concha is the most important part of the outer ear when it comes to reflections and resonances.

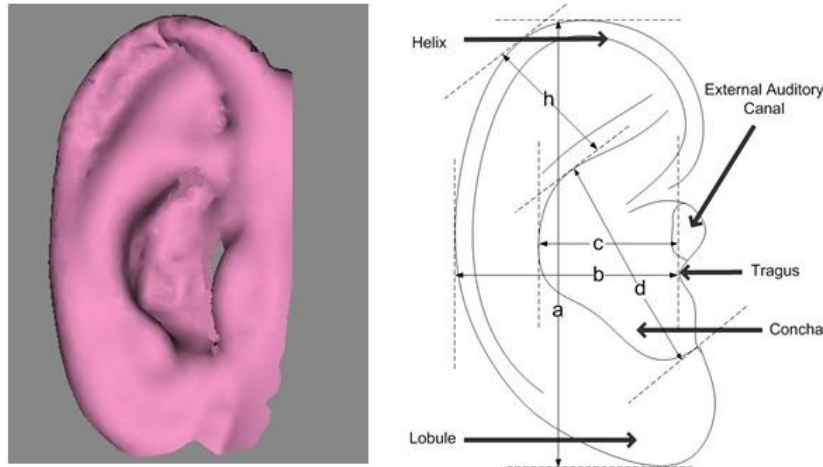

Figure 4. Pinna

PRTF & Measurement

- For a listener to perceive synthesized 3-D sound cues correctly, the synthesized cues must be similar to the listener's own PRTFs.
- One can measure individual PRTFs using specialized recording systems; however, these systems are prohibitively expensive and restrict the portability of the 3-D sound system. PRTF-based systems also face several computational challenges.
- To overcome these problems, sometimes generic PRTFs/HRTFs are used. Due to the loss of individual characteristics, binaural sounds generated using generic HRTFs suffer from higher errors and lower accuracy in localization.

Real Measurement

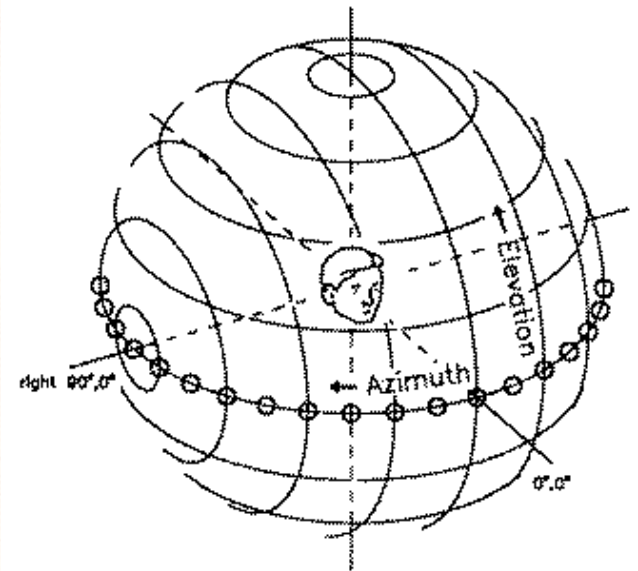

Figure 5. HRTF measurement

Research Plan

The paper includes these steps:

1. Measurement of Real PRTF of an artificial ear (pinna)
2. Find PRTF of a similar ear model in COMSOL that uses Finite Element Analysis method to solve the related Partial Differential Equations (PDEs). The model is also developed using COMSOL. Filter PRTF from using Moving Average Filter if required
3. Comparing the results from (1) and (2) for similarity and errors. These parameters are looked into for comparing:
 - Percentage Match
 - Average Error
 - Percentage Relative Error
 - Signal Complexity

Artificial Ear



Figure 6. Artificial Ears made of paper

Step I - Measurement of Real PRTF



Figure 7. PRTF measurements using the AuSIM HeadZap System

Azimuths 180° 150° 120° 90° 60° 30° 0° -30° -60° -90° -120° -150°

Elevations 54° 36° 18° 0° -18°

Combination of 12 azimuths and 5 elevations for this research



Measurement

- A speaker is placed at known relative positions with respect to the ear for which the PRTFs are being determined, and a known, broadband audio signal is used as excitation.
- At FIU's DSP laboratory, the Ausim3D's HeadZap HRTF Measurement System is used.
- This system measures a 256-point impulse response for the artificial ear using a sampling frequency of 96 KHz.
- Impulse signal generated through a Bose Acoustimass speaker.
- The response is measured using miniature blocked meatus microphones placed at the entrance to the ear canal on each side of the head. Microphones have high signal-to-noise ratio (SNR),

Results

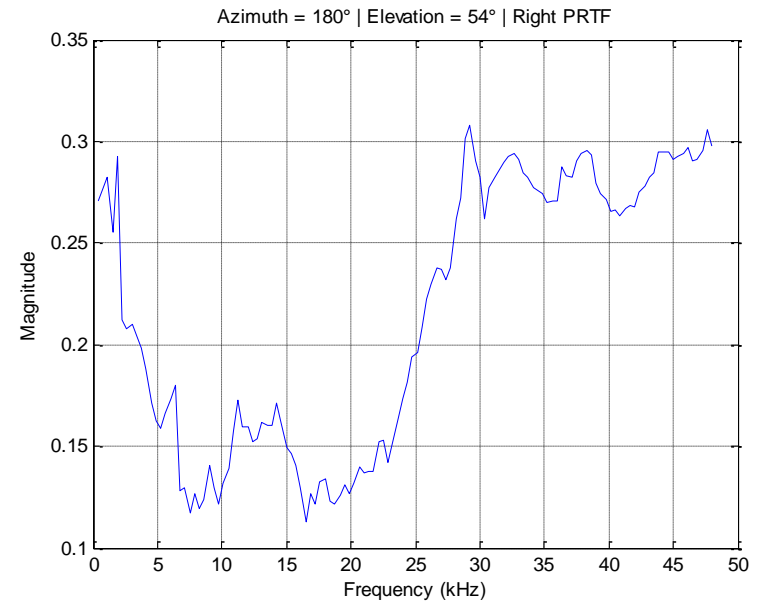
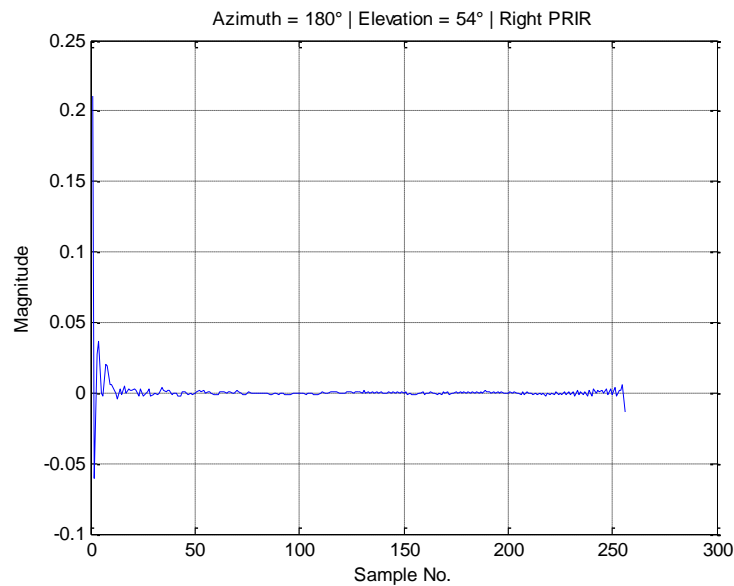

Figure 9. PRIR (Left) & PRTF (Right) of the artificial ear with sound source at Azimuth 180° and Elevation 54°

Step 2 - Artificial Synthesis of PRTF using COMSOL

- Using Pressure Acoustic Interface of Acoustic Module
- Recreating the real measurement scenario in Comsol
- In this model, a point source generates a pressure wave. The sound level is measured at another point (inside the ear canal) and at an audible range of frequencies (from 0 Hz to 10 kHz).
- The measured sound level can be studied to see the changes that the sound waves go through after interacting with the ear/pinna walls.
- In the first phase of this research, instead of using a scanned image of the artificial ear, a model with similar dimensions was drawn in COMSOL. In the second phase, the 3D scanned images from FIU DSP lab will be used.

COMSOL Simulation

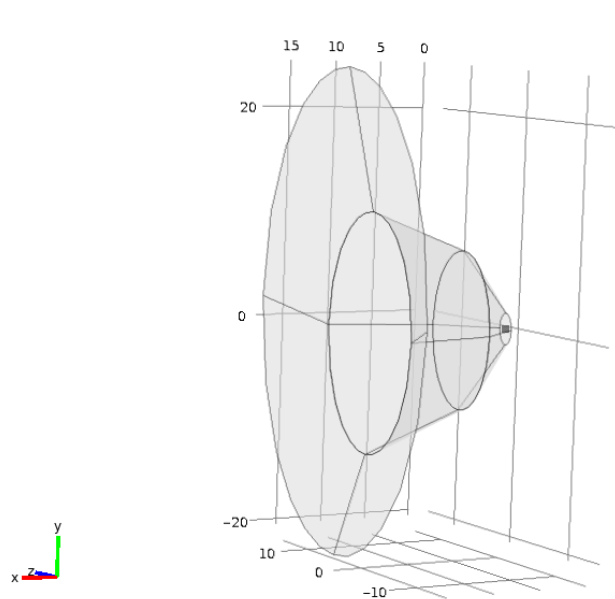

Figure 10. Artificial Ear model in COMSOL– 30 mm W x 20 mm D x 50 mm H

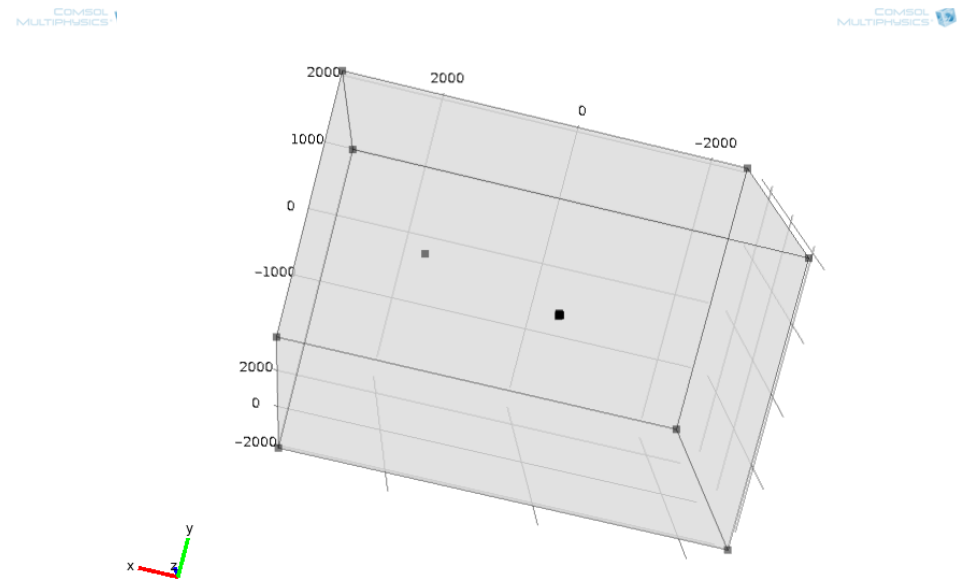

Figure 11. Room (6 m W x 6 m D x 4 m H) – filled with air
Two points seen – (1) Artificial Ear (2) Sound source

Simulation Parameters & Mesh Creation

P_i Parameters

Parameters

Name	Expression	Value	Description
rho0	1.2[kg/m^3]	1.2 kg/m ³	Air density
cs	343.8[m/s]	343.8 m/s	Speed of sound in air
f0	10000[Hz]	10000.0 Hz	
L	cs/f0	0.03438 m	Shortest wavelength
S	1e-5[m^3/s]	1.0E-5 m ³ /s	Flow source strength

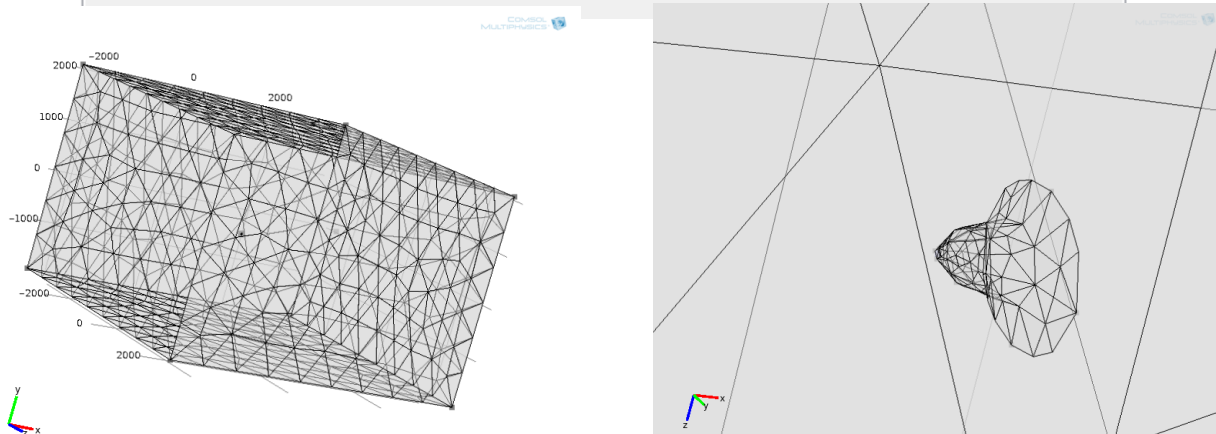

Figure 12. Mesh created to solve using the Finite Element Method
Mesh Size = $5 * L$; L is the shortest wavelength = cs/f_0

Equations

- The acoustic wave propagation in the room is governed by the following Helmholtz equation for harmonic sound waves of acoustic pressure $p(\mathbf{x},t) = p(\mathbf{x})e^{i\omega t}$:

$$\nabla \cdot \left(-\frac{1}{\rho_0} \nabla p \right) - \frac{\omega^2 p}{\rho_0 c_s^2} = Q$$

where ρ_0 is the density (kg/m³), $\omega = 2\pi f$ denotes the angular frequency (rad/s), c_s refers to the speed of sound (m/s), and Q (1/s²) is a monopole source.

- A point source flow of strength $S = 10^{-5}$ m³/s located at the point $\mathbf{R}_0 = (x, y, z)$ drives the system, so that

$$Q = \omega S \delta^{(3)}(\mathbf{R} - \mathbf{R}_0)$$

where $\delta^{(3)}(\mathbf{R})$ is the 3D Dirac delta function.

Comsol uses the Finite Element Method to solve the above differential equation

COMSOL Simulation

- Assuming, that the ear walls are perfectly reflecting, and the room walls are radiating so that no waves are reflected back into the room from the walls, the sound level is measured at the point $R_1 = (0, 0, 0)$ at a range of frequencies from 0 Hz to 10 kHz.
- The sound pressure at point R_1 is studied by varying the location of R_0 . The angle between R_1 and R_0 are varied along the horizontal plane (azimuth) and the vertical plane (elevation) as shown below. The sound pressure at R_1 represents the simulated Pinna Related Transfer Function (PRTF).

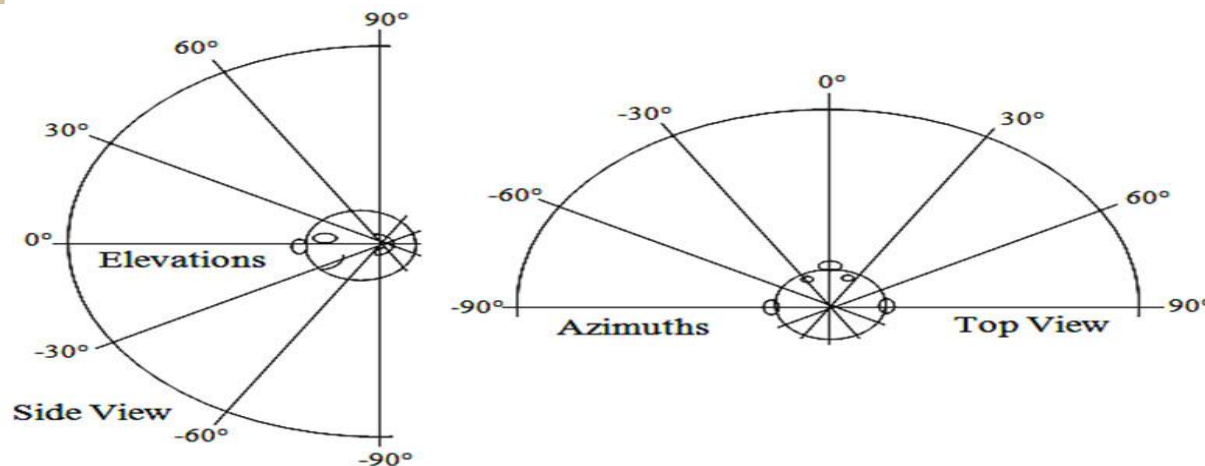

Figure 13. Azimuth and Elevations

Results

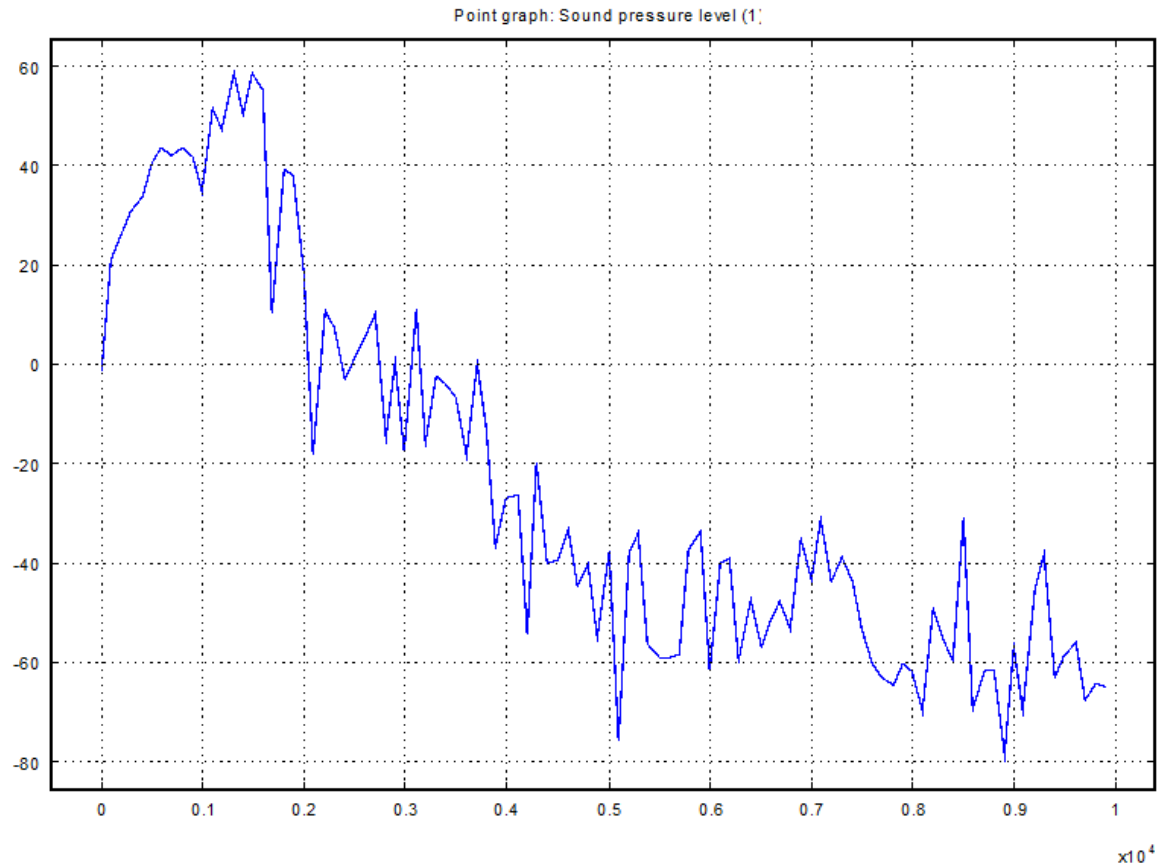

Figure 14. Sound pressure level at R_1 (0° azimuth / 30° elevation) – or PRTFs Range: 0 Hz to 10 kHz at a step size of 100 Hz. The data from COMSOL is exported as a text file.

Filtering the PRTF using MVA

- The moving average filter operates by averaging a number of points from the input signal to produce each point in the output signal.

$$y [i] = \frac{1}{M} \sum_{j=0}^{M-1} x [i + j]$$

where x is the input signal (being filtered), y is the output signal and M is the number of points in the average (window size).

Step 3 - Comparison using MATLAB GUI

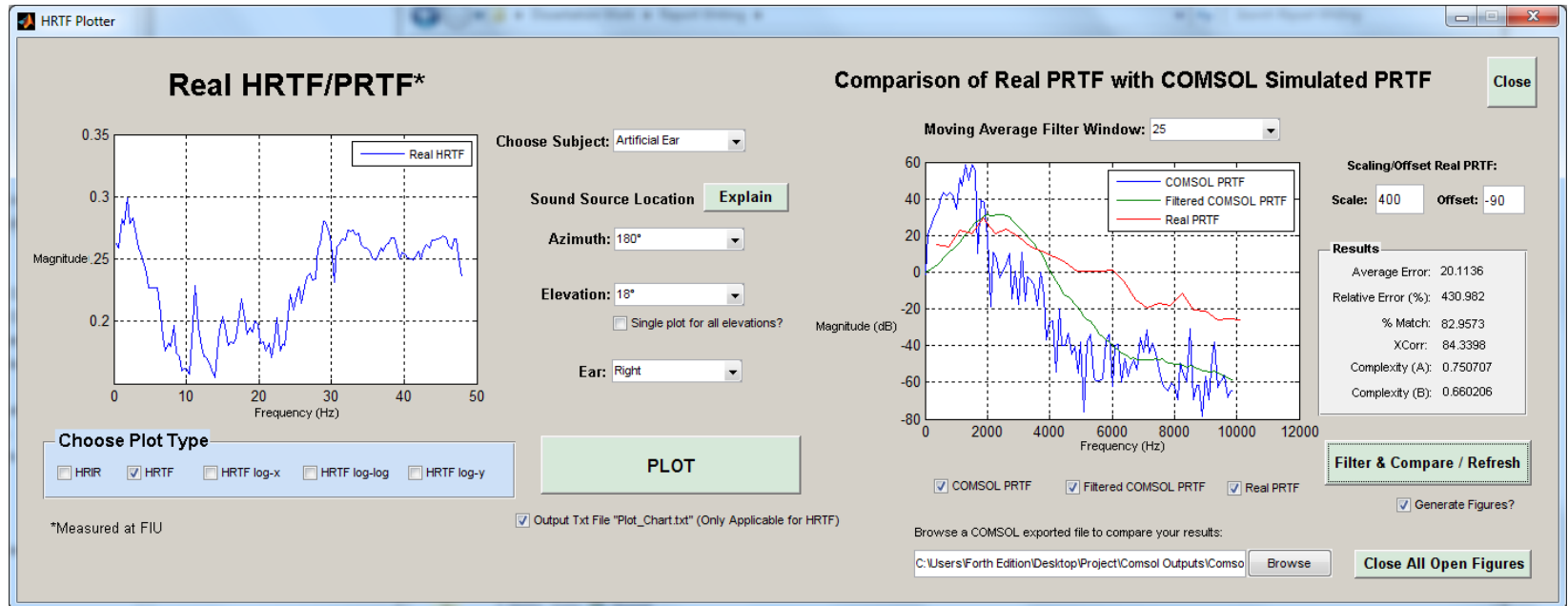

Figure 15. GUI developed using MATLAB to perform comparison and error analysis

Results & Comparison

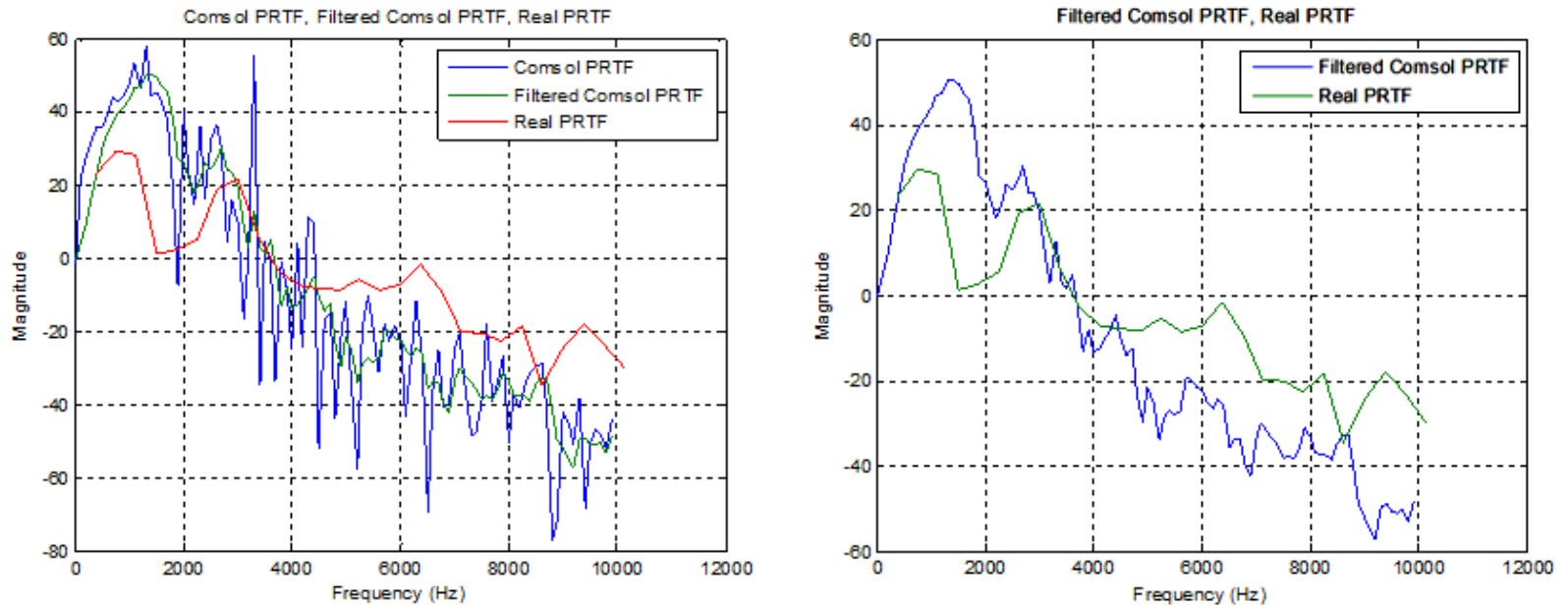

Figure 16. Plot showing the Comsol PRTF, Filtered Comsol PRTF and Real PRTF for sound source location 180° azimuth and 0° elevation. The filtered COMSOL PRTF (Green) and Real PRTF (Red) are similar in the range of 0 to 10 kHz (frequency range of interest). The Moving Average Filter window size is 3.

Parameters Compared

Results

Average Error: 20.1136

Relative Error (%): 430.982

% Match: 82.9573

XCorr: 84.3398

Complexity (A): 0.750707

Complexity (B): 0.660206

Future Work

- The PRTF for scanned 3-D real ear images from FIU database will be used to generate PRTFs in COMSOL. The database contains the HRIRs and 3-D images of 15 subjects.

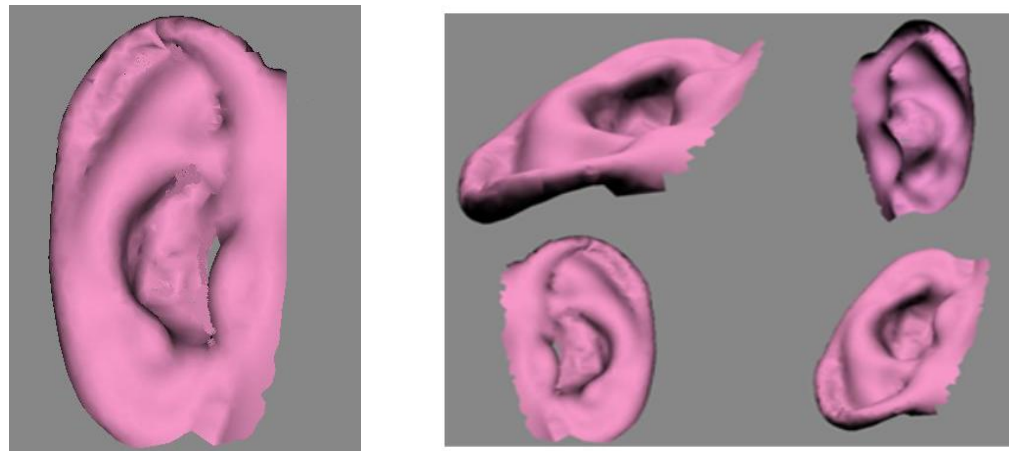

Figure 18. 3-D image taken by a hand-held scanner (source FIU's DSP lab)

- This will allow us to test our simulation across 30 images (15 subjects x 2 ears) and 72 sound source locations.

Conclusion

- This research provides an easier way of measuring PRTFs, where the 3-D images of pinna are used to obtain the PRTFs.
- % Match and Correlation with the real PRTF up to 80%.