

Failure Modes of Underground MV Cables: Electrical and Thermal Modelling

P A Wallace
M Alsharif
D M Hepburn
C Zhou



What is This Nasty Looking Object?





3 Phase Paper Insulated Lead Covered (PILC) Cable

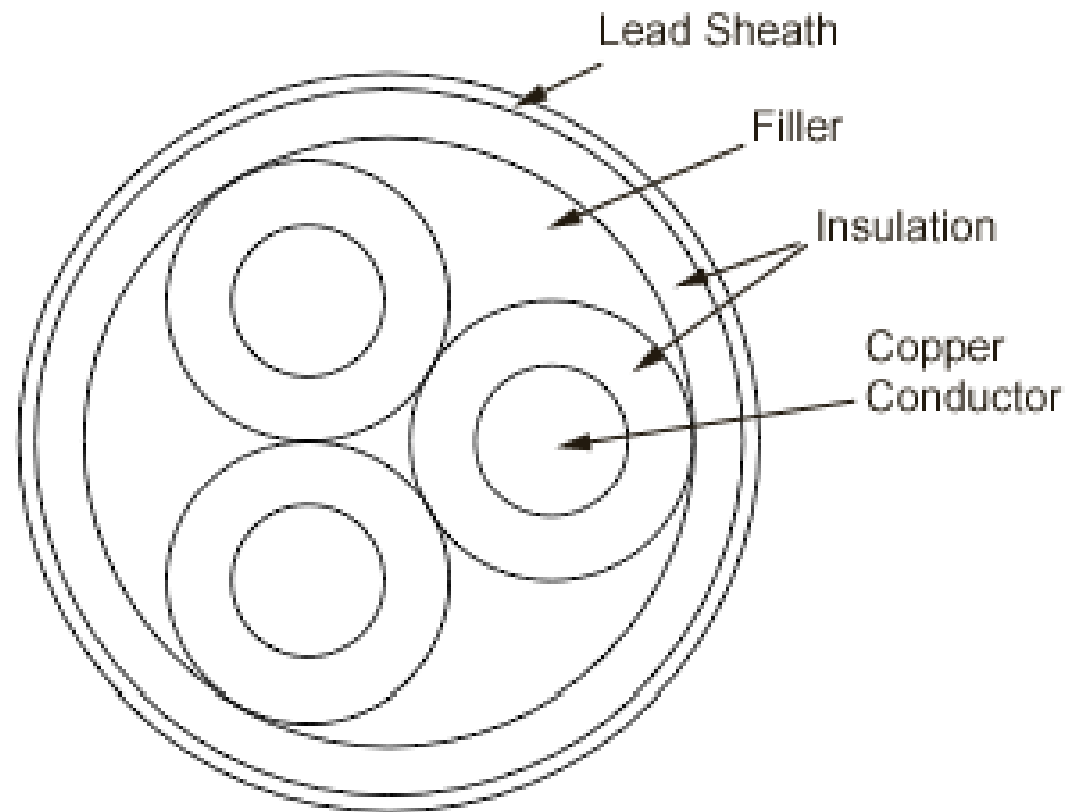



Medium Voltage Distribution Network

- Between the HV transmission network..
(long distance, 100s kV, frequently overhead)
- ..and the household electricity supply..
(230 V, domestic)
- ..lies the MV distribution network.
(moderate distances, 10s kV, frequently underground)



Inventory of MV cables by Year of Installation

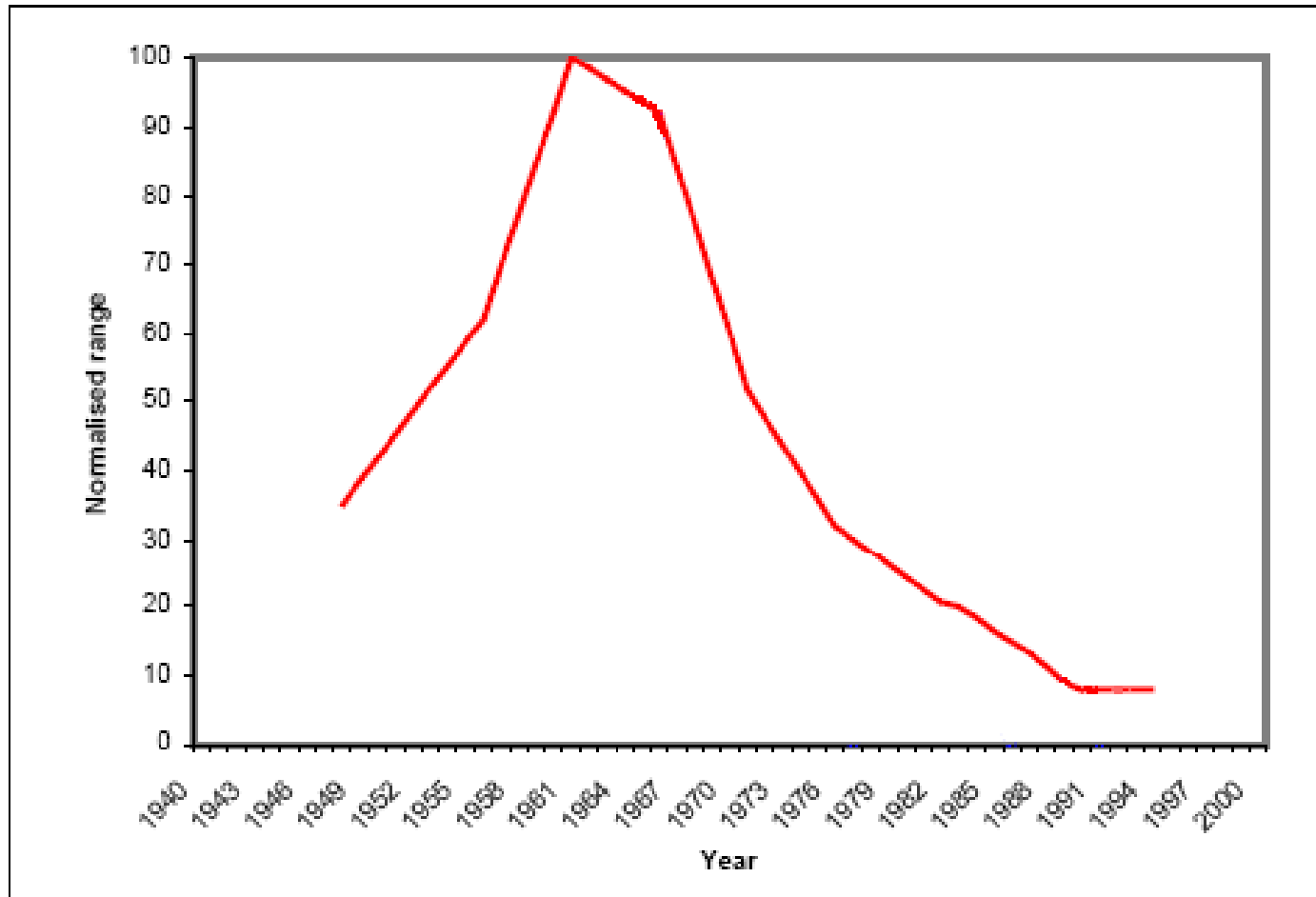

Supplied by ' a Utility Company'



A Legacy Infrastructure (in large Part..)

- A 'utility company' has 38000 km of MV cable within its area of operation.
- Much of the cable infrastructure is operating beyond its design life expectancy.
- The current rate of replacement is 100 km/year
- On-line condition monitoring sensors are being installed to detect Partial Discharge (PD) activity..
- ..but how to interpret the data?



Partial Discharge

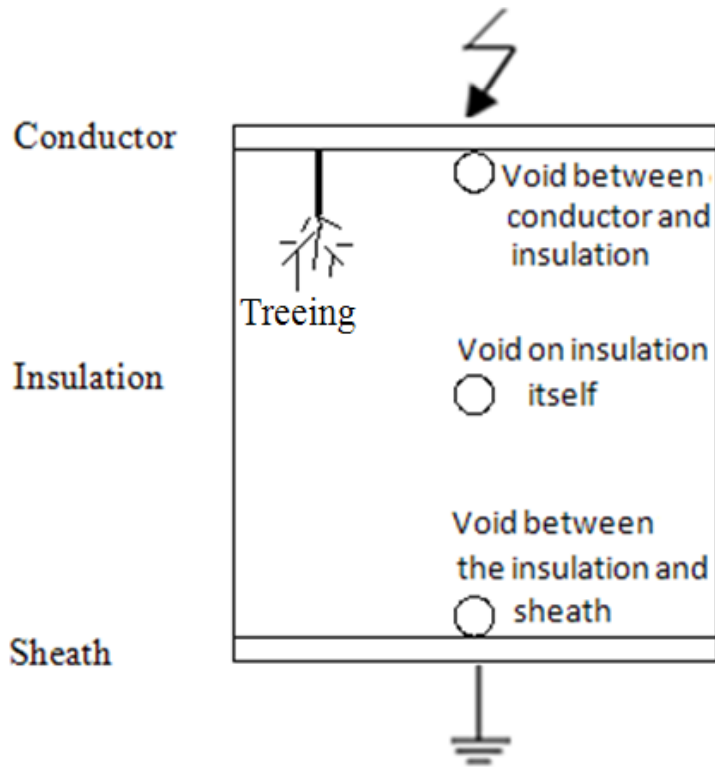

PD is a localized electrical discharge that only partially bridges the insulation between conductors which may or may not occur adjacent to a conductor.



Partial Discharge – E Field in Discharging Void

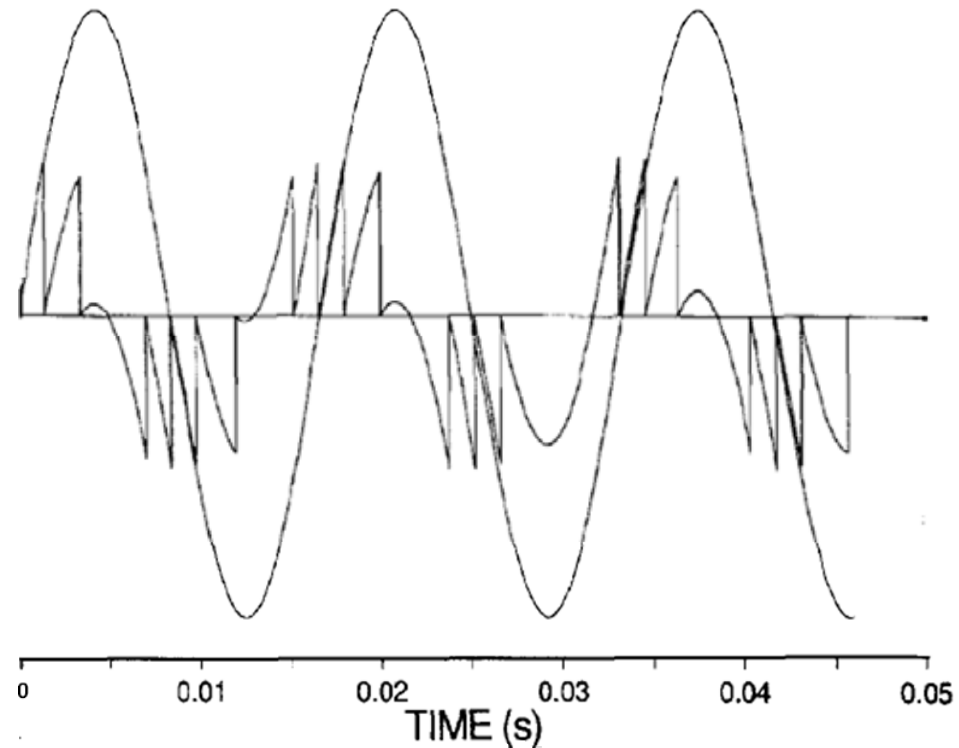

from

Boggs, S. A. (1990) Partial Discharge - Part 111:Cavity-Induced PD in Solid Dielectrics. IEEE Electrical Insulation Magazine, 1990-Vo1.6, No.6



Correlation between Cable Load and PD Activity

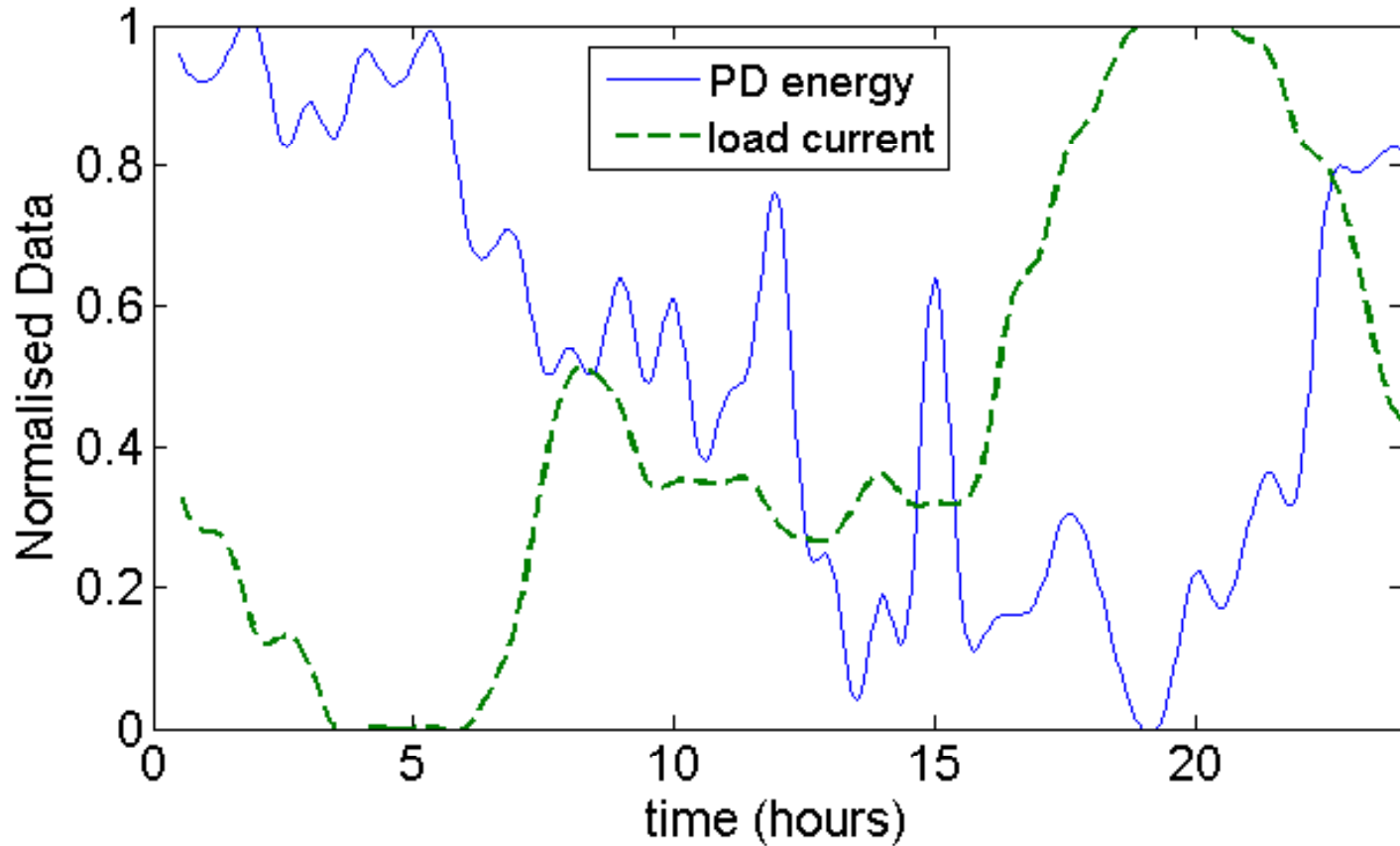

From the same 'Utility Company'



Two Models

- A long time scale (hundreds of hours) thermal model..

..will provide the background conditions for a..

- ..short time scale (20 ms!) electrostatic model.



Electrostatic Model

$$-\nabla \cdot (\epsilon_0 \epsilon_r \nabla V) = \rho$$

$$\mathbf{E} = -\nabla V$$

Subject to BC

Sheath : $V = 0$

Conductors : $V(t) = V_0 \cos(\omega t + 2n\pi/3) \quad n = 0, 1, 2$



Electric Field in PILC Cable

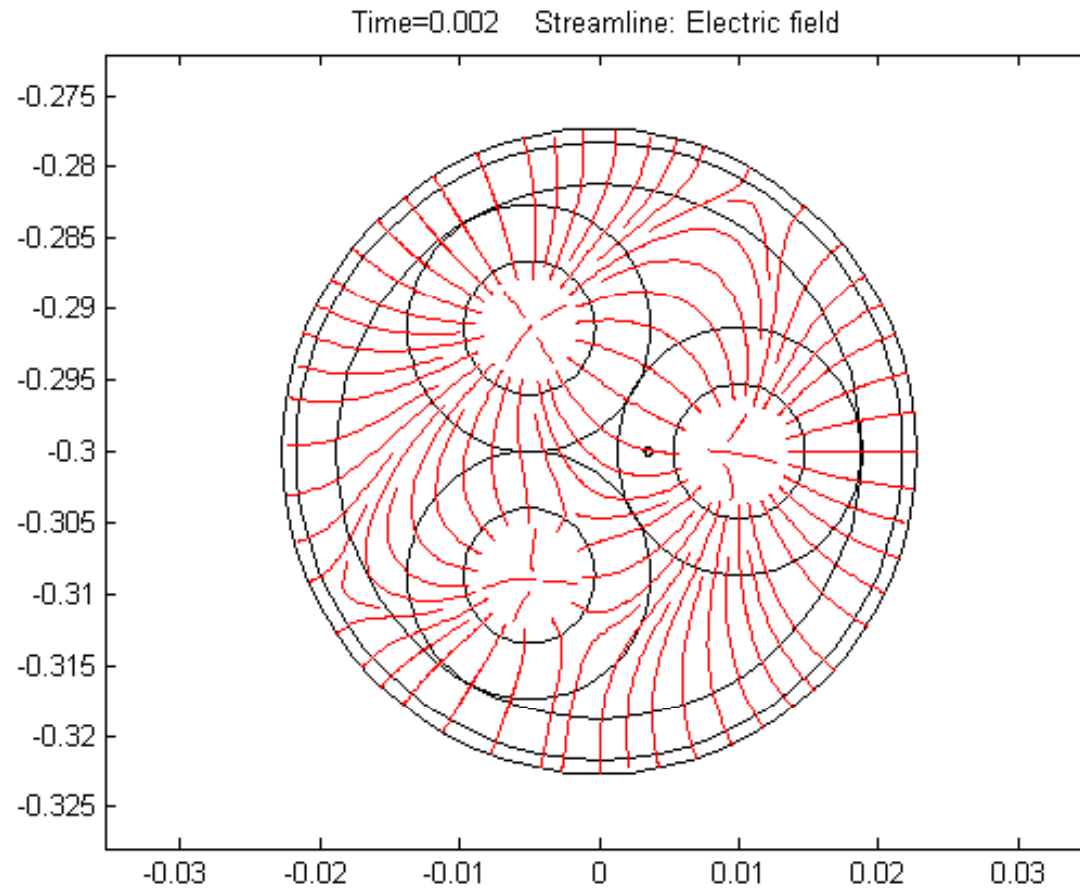



Increased Field in Insulator Void

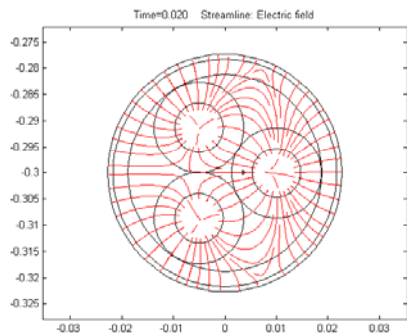
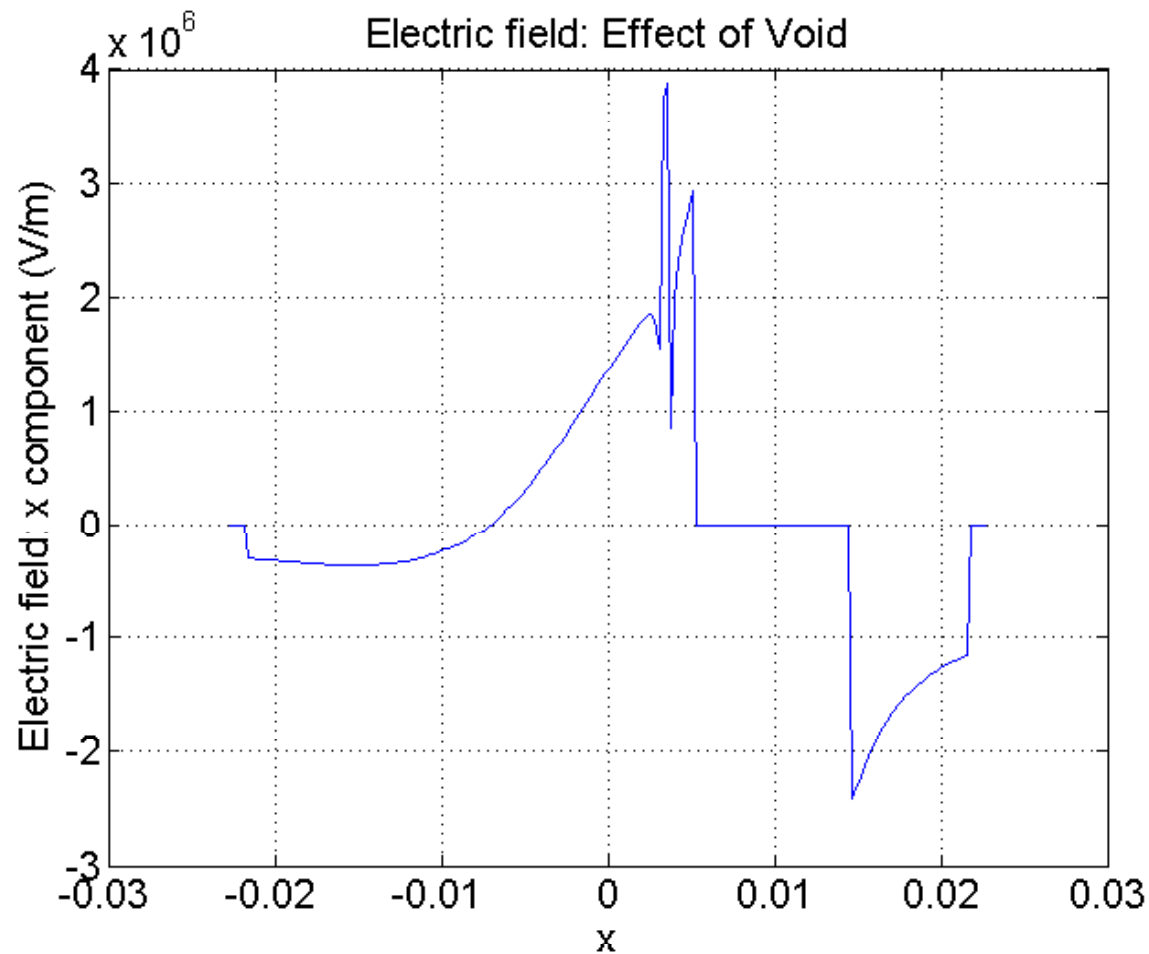



Tangential Component of Field within Insulation Belt

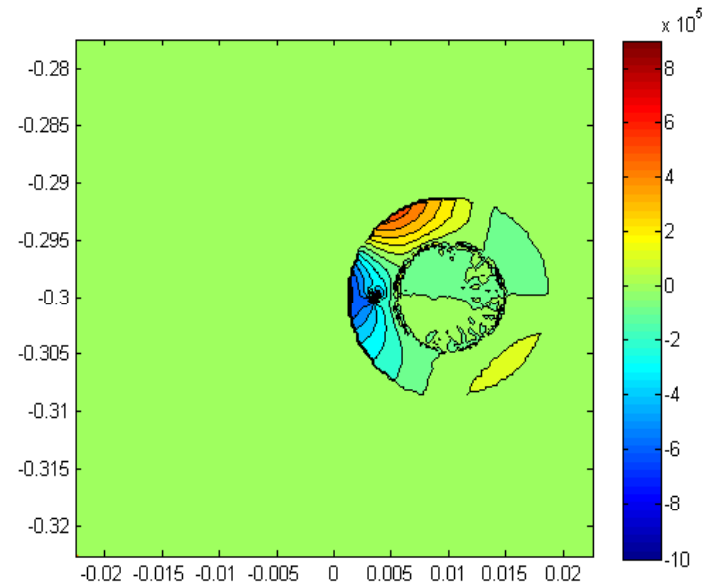
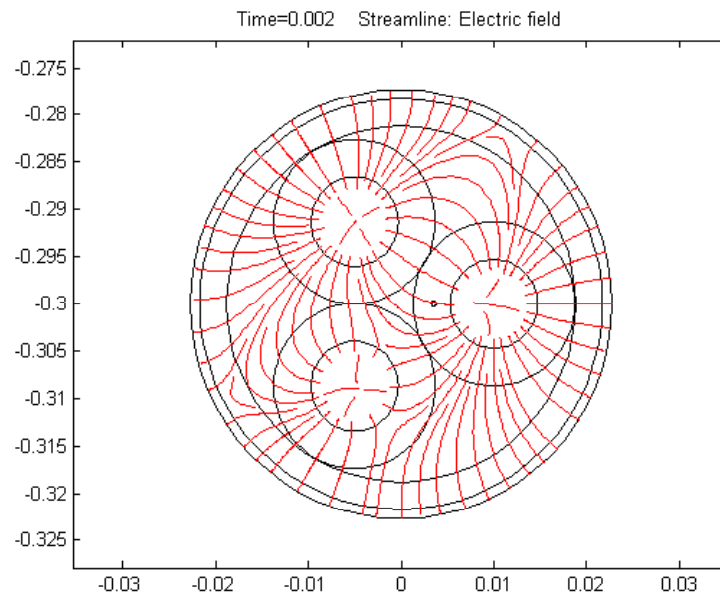



$$\rho C_p \frac{\partial T}{\partial t} + \nabla \cdot (k \nabla T) = Q$$

where $Q = Q_c + Q_s$ (conductor and sheath contributions)

$$Q_c = \frac{I^2 R}{A_c}$$

$$Q_s = \lambda \frac{Q_c}{A_s}$$

following BS IEC 60287 - 1-1: 2006

Subject to IC: $T(t) = 288 \text{ K}$

Subject to BC: $T_{\text{boundary}} = 288 \text{ K}$



Step Reponse

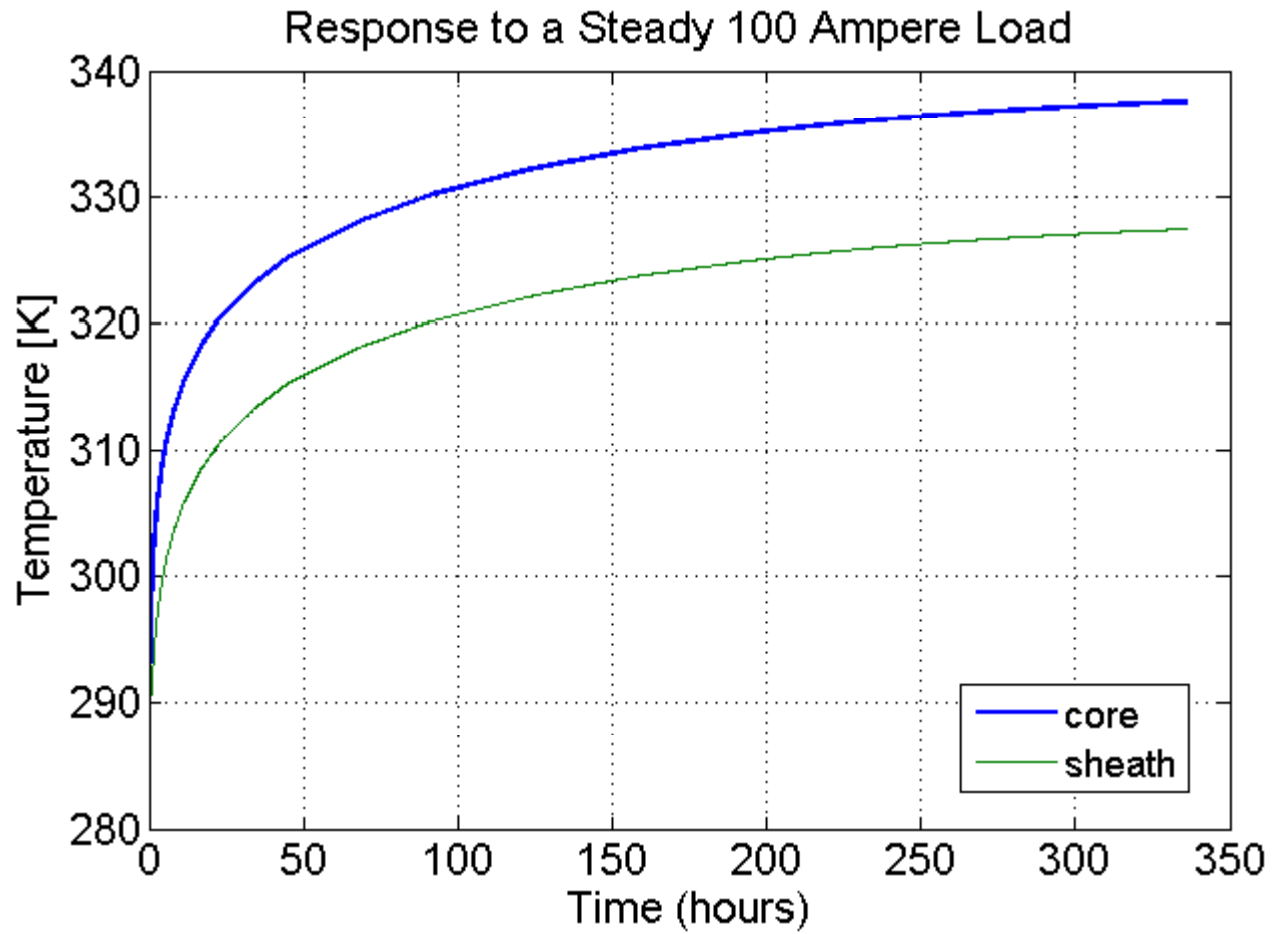



Response to Real Load over One Week

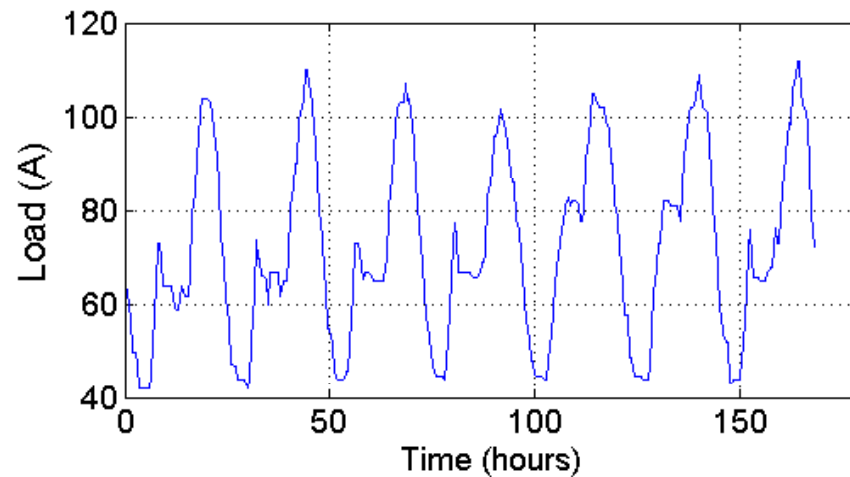
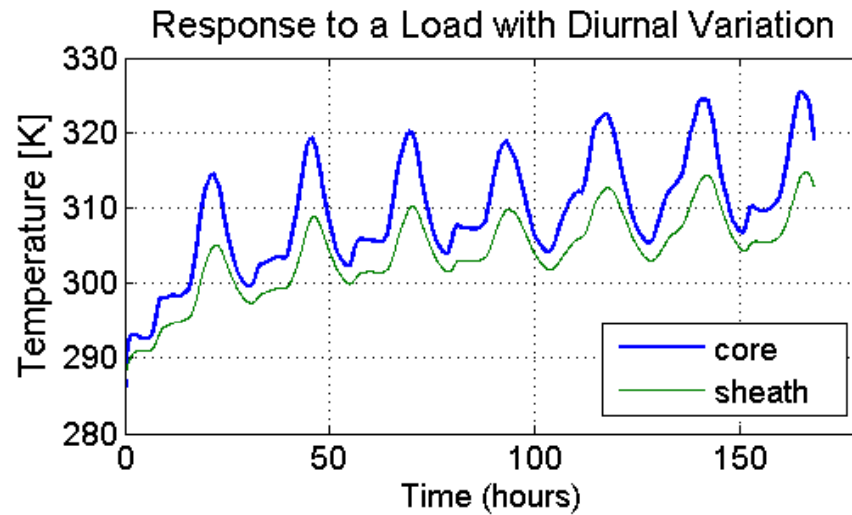

Load Data from the usual 'Utility Company'



Temperature Distribution within Cable

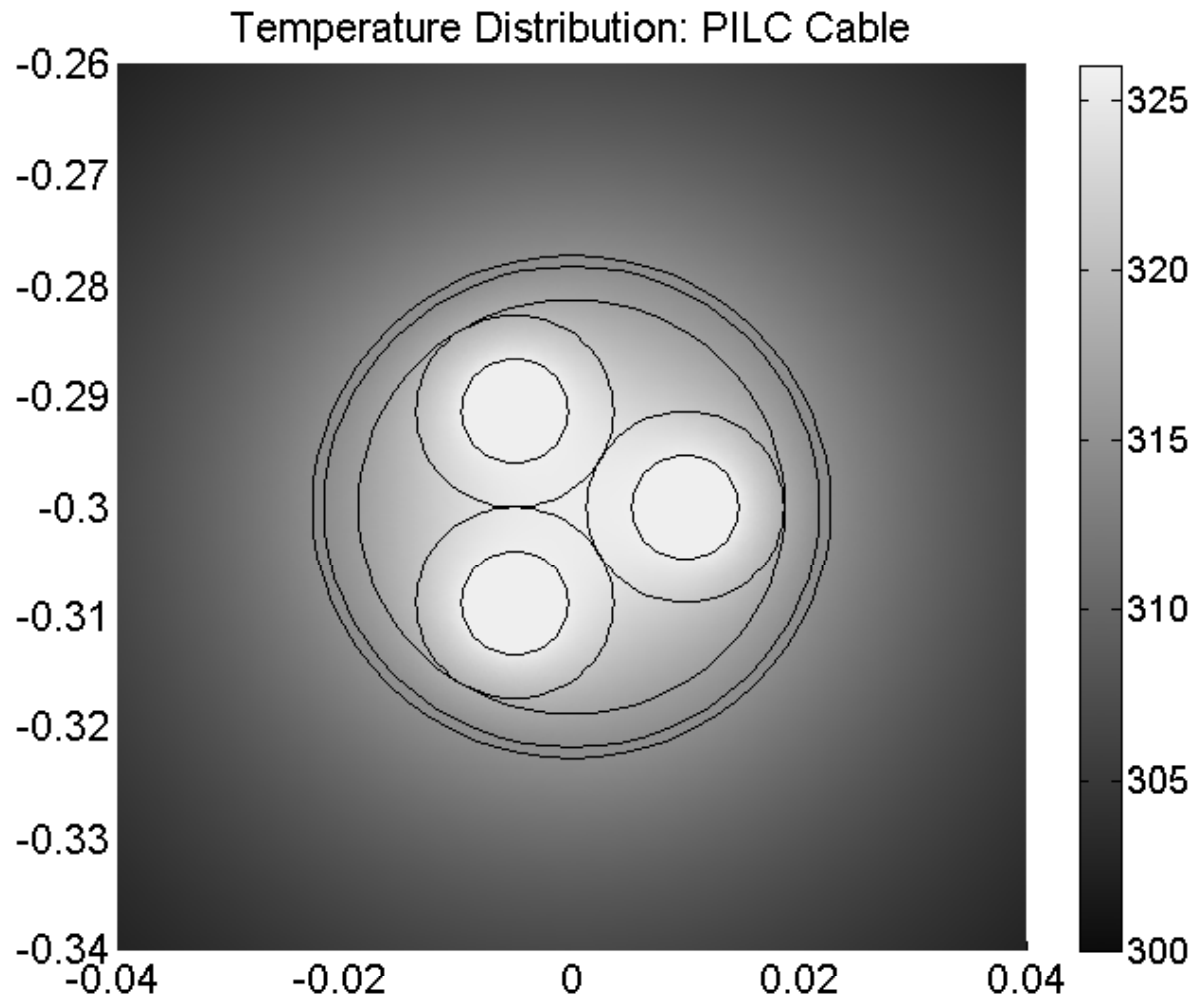



Comparisons requires with existing commercial products, for example..

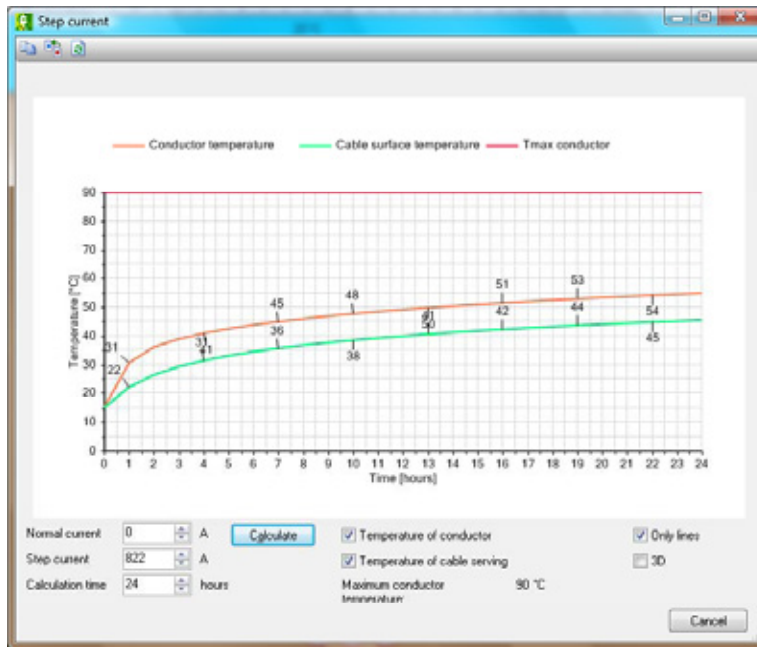

The 'Info' window displays the following information:

PHASE TO PHASE

Phase to Phase BV
Utrechtseweg 310
Postbus 100
6800 AC Arnhem
T: 026 352 37 00
F: 026 352 37 09
kabel@phasetophase.nl
www.phasetophase.nl

VISION

Cable analysis

Version 1.4.2
Demo

© 2005-2008 Phase to Phase BV, Arnhem, The Netherlands. All rights reserved.
Phase to Phase BV disclaims liability for any direct, indirect consequential or
may result from the use of the information or data in this
ility to use the information or data.

OK

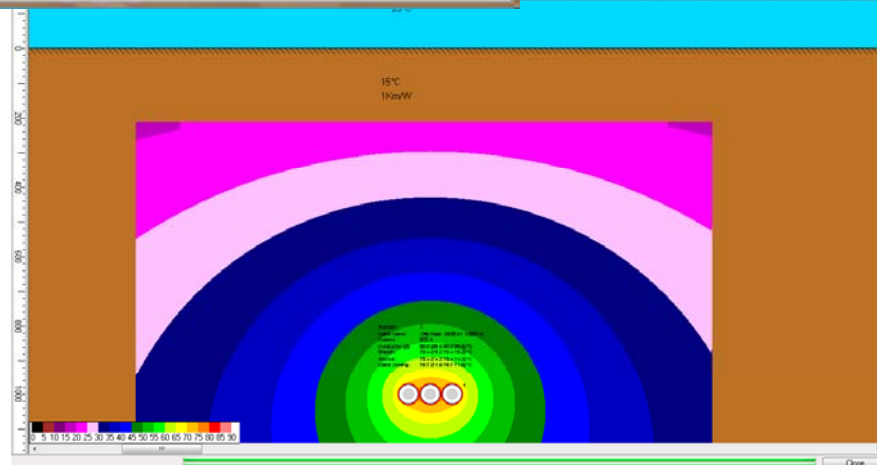



- Incorporate Thermo-Mechanical Effects into the long term model.
- Run the short time scale model using the background conditions of temperature and deformation established by the long term model

THANK YOU
FOR YOUR ATTENTION